

# **100 Kreiswörter mit 6 Buchstaben Teil 1**

Sascha Frank  
[www.kreiswort.de](http://www.kreiswort.de)

12. Dezember 2012

Die gesuchten Wörter sind in einem Kreis aus Buchstaben versteckt. Das Wort kann vorwärts und rückwärts im Kreis stehen. Insgesamt gibt es 100 Rätsel zu lösen, am Ende gibt es eine kurze Lösung.

Mit freundlicher Unterstützung von:

Autobett Kinderzimmer F1, Wimperverlängerung Freiburg, Dreisatzrechner

## Gesucht

ABFLUG	GNOSIS	RECHEN
ABHANG	GRANAT	REKORD
ANORAK	GRUPPE	RENNER
BALLON	GULDEN	RIEMEN
BANDIT	HAMMER	SAFRAN
BASSIN	HOCKEY	SCHEIT
BAUART	IRONIE	SCHERZ
BECKEN	JODLER	SCHILD
BEIRAT	JUSTIZ	SCHNUR
BETRAG	KASINO	SCHUFT
BISTUM	KNACKS	SCHUTZ
BOHRER	KNOSPE	SCHWAN
BREZEL	KNOTEN	SIGNAL
BROKAT	KOGNAK	SKETCH
BRUTTO	KONTUR	SOCKEL
BUTTER	KUPPEL	STATIV
CABRIO	LEGION	STEUER
CLIQUE	LESUNG	STRICK
DACKEL	MENTOR	TAIFUN
DEKRET	MUSEUM	TASCHE
EFFEKT	MYSTIK	TEXTUR
EIGNER	NACKEN	TRACHT
EPOCHE	NEIDER	TREPPE
ERDUNG	NORDEN	TRUBEL
ERSATZ	OKULAR	TRUPPE
FAHRER	ORANGE	UMLAUT
FINDER	PALAST	VALIUM
GARANT	PATZER	VERBOT
GEBELL	PAUKER	VILLEN
GEHABE	PFIFFE	WECKER
GEHIRN	PRACHT	WETTER
GEIGER	PUFFER	ZUCKER
GLASUR	RADIUS	ZUFALL
		ZYKLEN

Rätsel Nummer 1

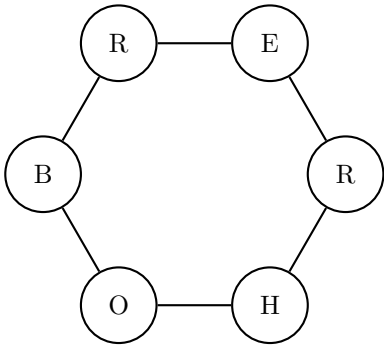

Rätsel Nummer 2

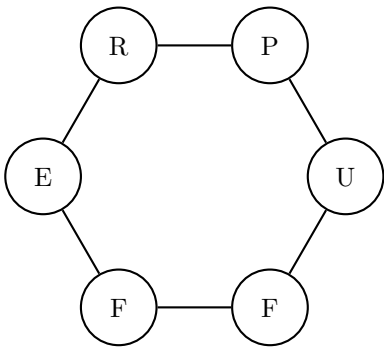

Rätsel Nummer 3

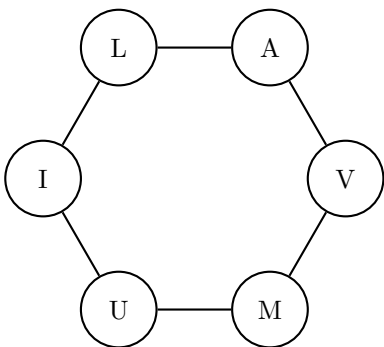

Rätsel Nummer 4

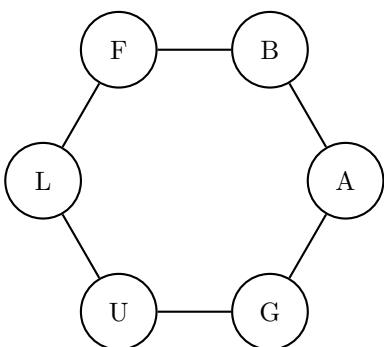

Rätsel Nummer 5

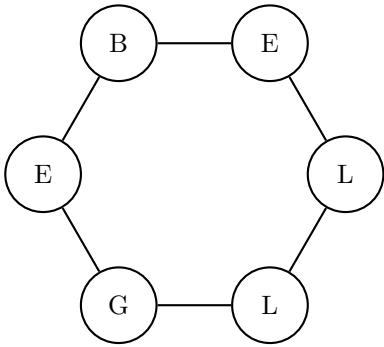

Rätsel Nummer 6

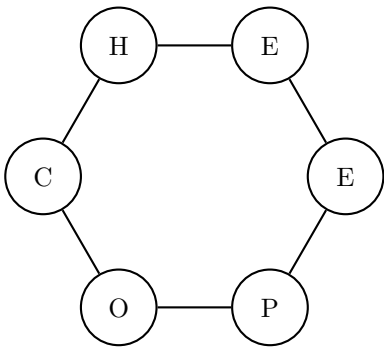

Rätsel Nummer 7

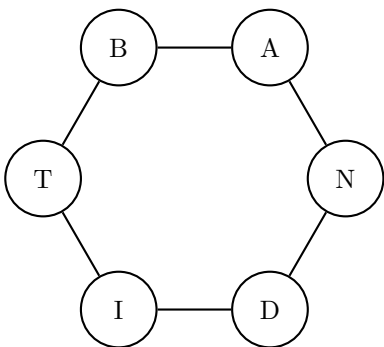

Rätsel Nummer 8

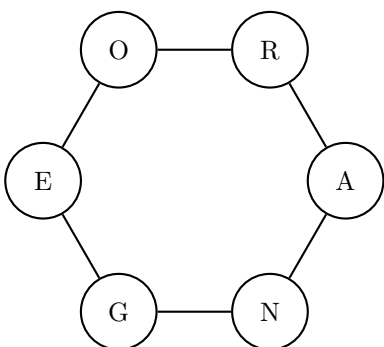

Rätsel Nummer 9

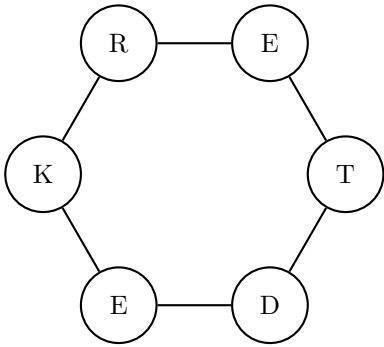

Rätsel Nummer 10

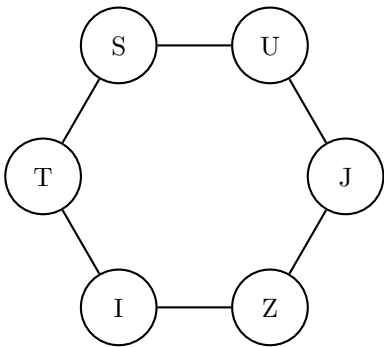

Rätsel Nummer 11

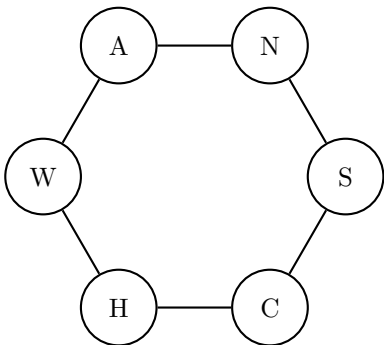

Rätsel Nummer 12

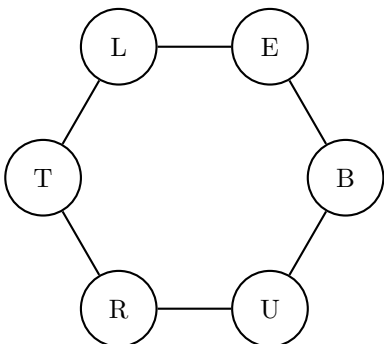

Rätsel Nummer 13

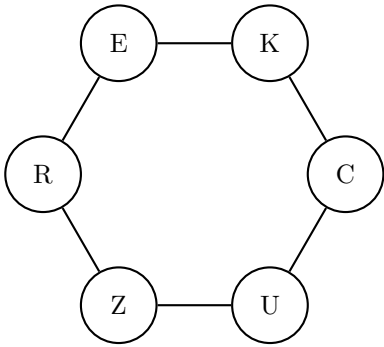

Rätsel Nummer 14

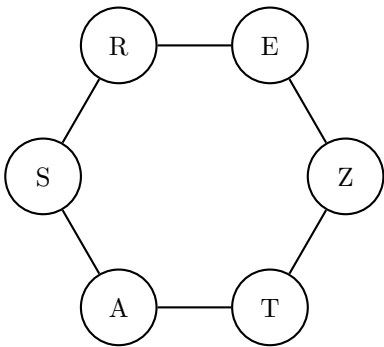

Rätsel Nummer 15

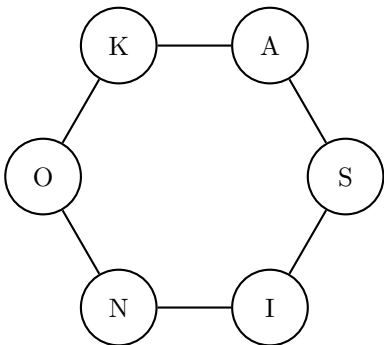

Rätsel Nummer 16

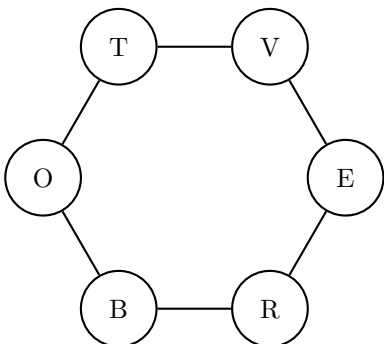

Rätsel Nummer 17

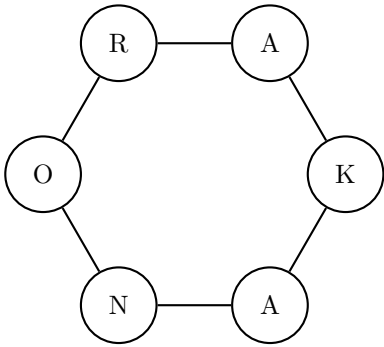

Rätsel Nummer 18

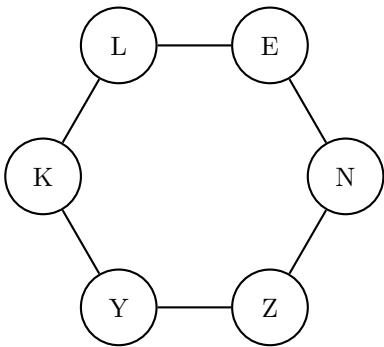

Rätsel Nummer 19

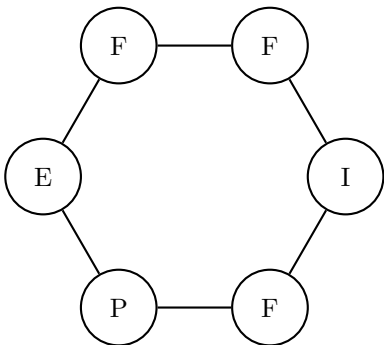

Rätsel Nummer 20

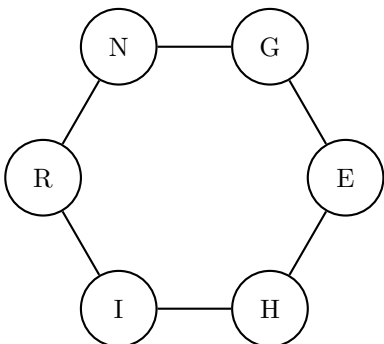



Rätsel Nummer 21

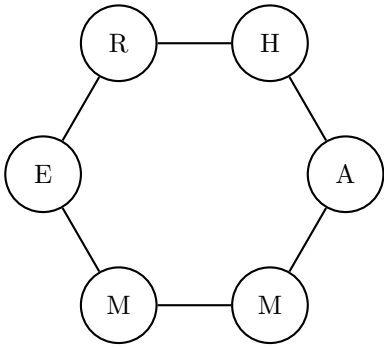

Rätsel Nummer 22

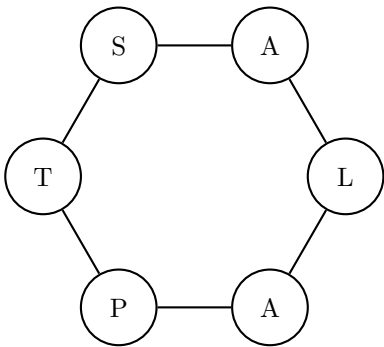

Rätsel Nummer 23

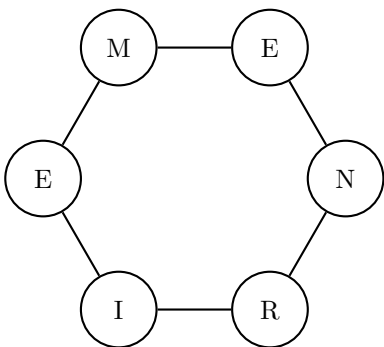

Rätsel Nummer 24

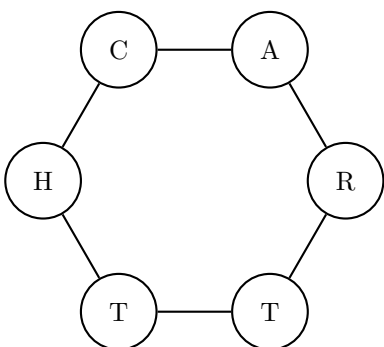

Rätsel Nummer 25

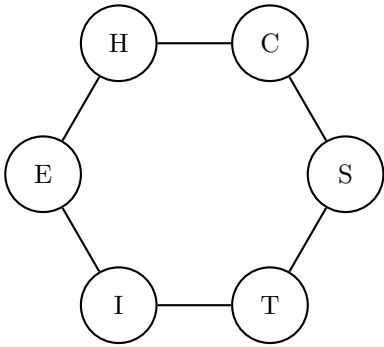

Rätsel Nummer 26

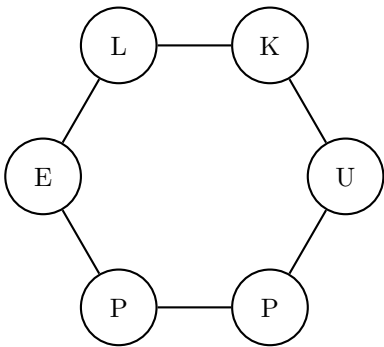

Rätsel Nummer 27

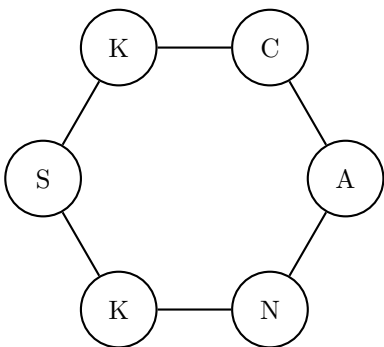

Rätsel Nummer 28

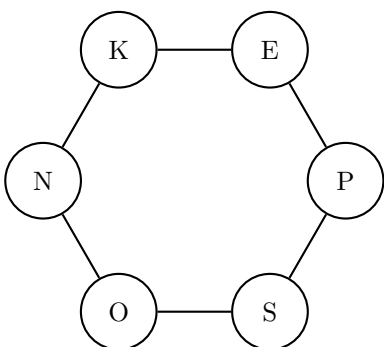

Rätsel Nummer 29

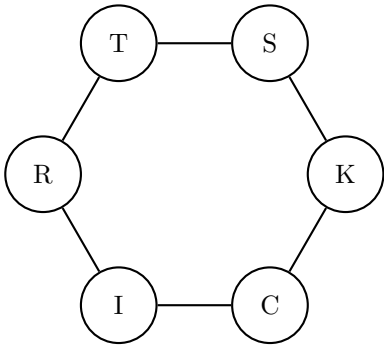

Rätsel Nummer 30

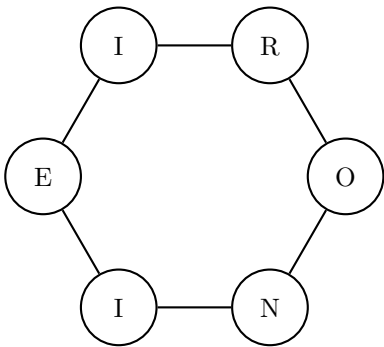

Rätsel Nummer 31

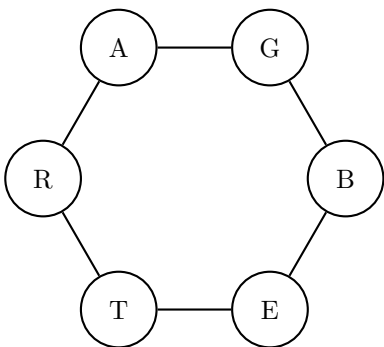

Rätsel Nummer 32

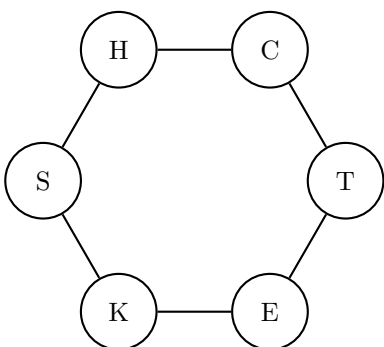

Rätsel Nummer 33

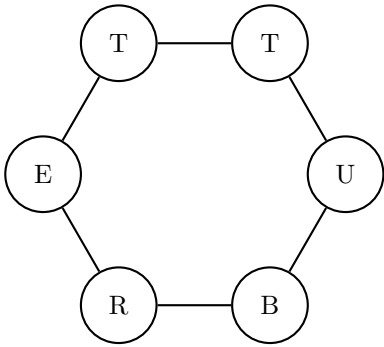

Rätsel Nummer 34

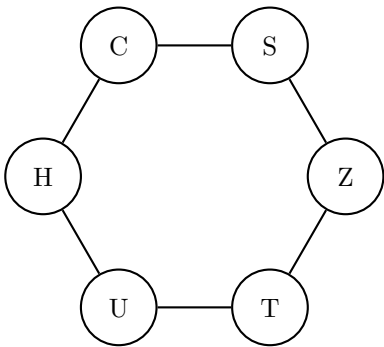

Rätsel Nummer 35

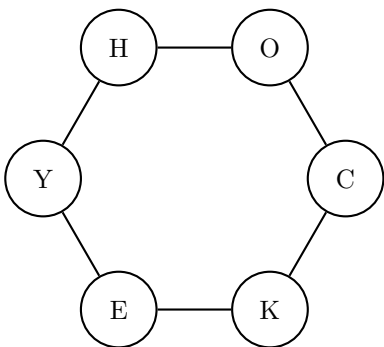

Rätsel Nummer 36

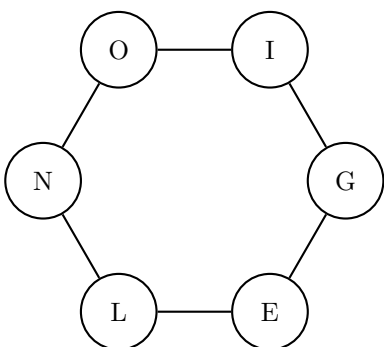

Rätsel Nummer 37

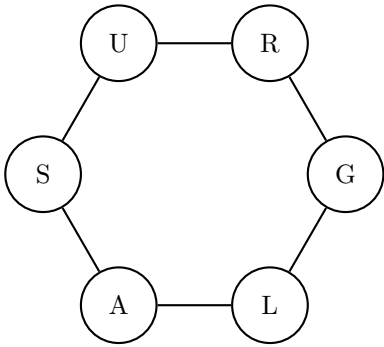

Rätsel Nummer 38

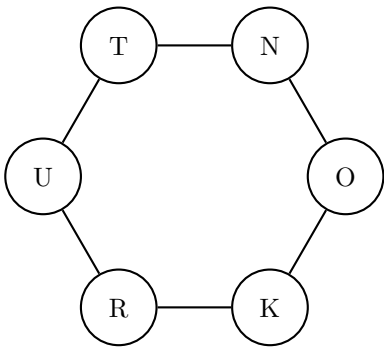

Rätsel Nummer 39

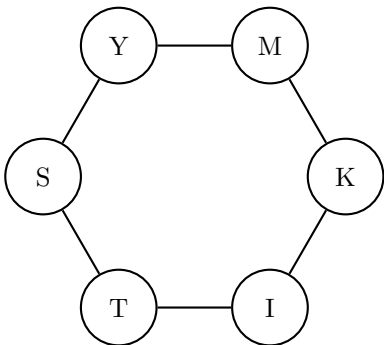

Rätsel Nummer 40

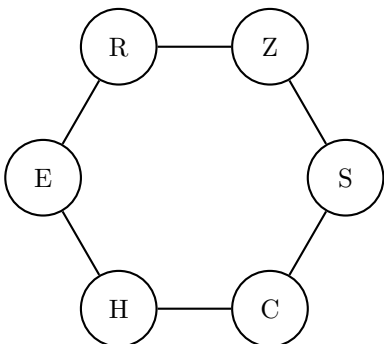

Rätsel Nummer 41

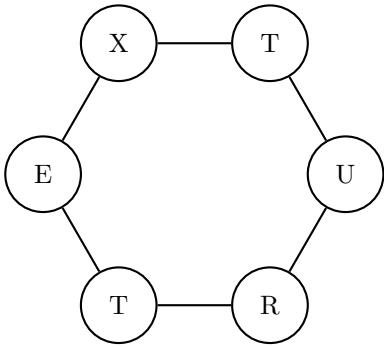

Rätsel Nummer 42

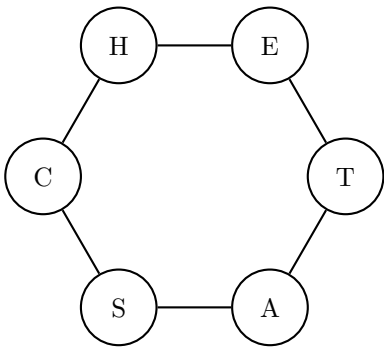

Rätsel Nummer 43

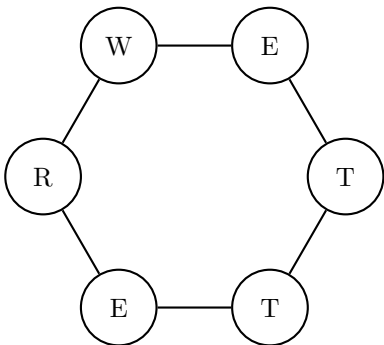

Rätsel Nummer 44

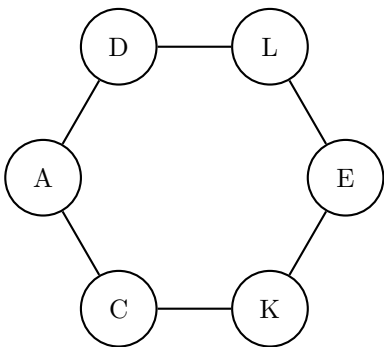

Rätsel Nummer 45

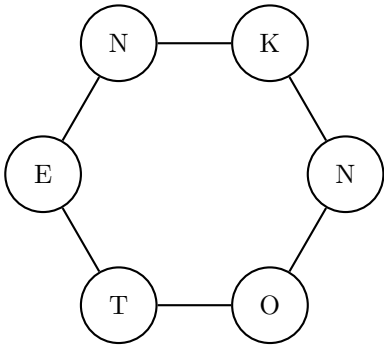

Rätsel Nummer 46

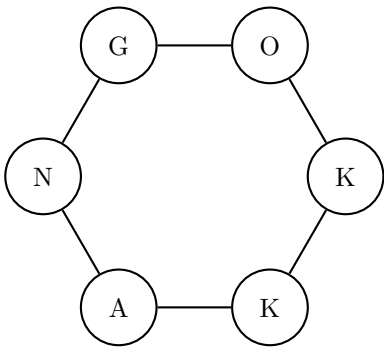

Rätsel Nummer 47

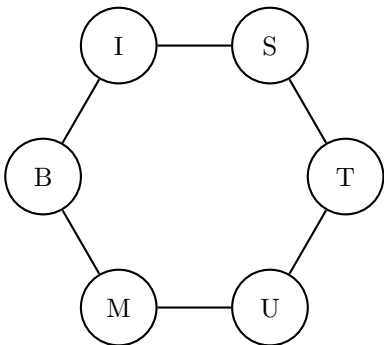

Rätsel Nummer 48

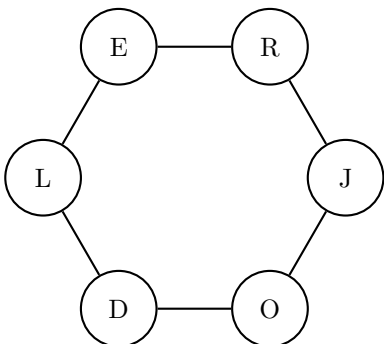

Rätsel Nummer 49

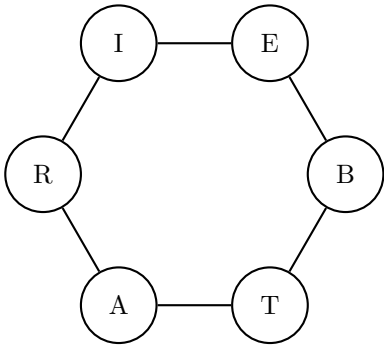

Rätsel Nummer 50

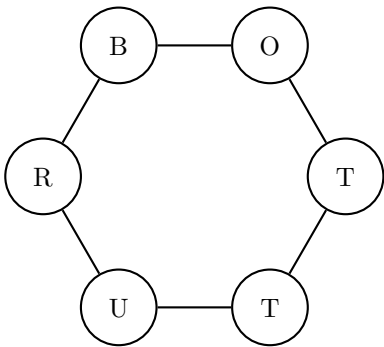

Rätsel Nummer 51

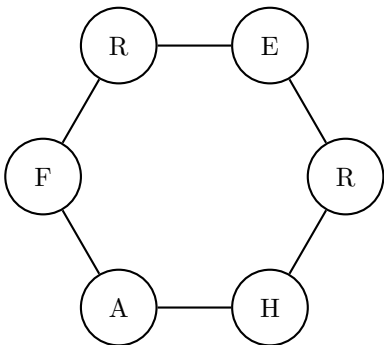

Rätsel Nummer 52

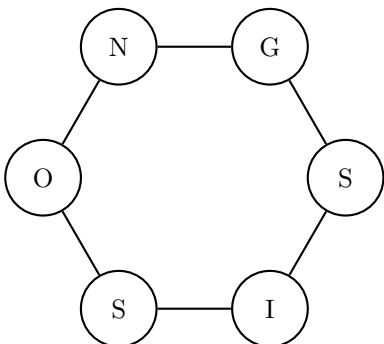



Rätsel Nummer 53

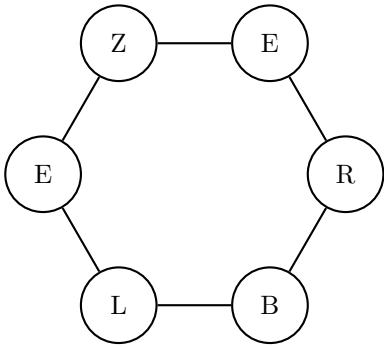

Rätsel Nummer 54

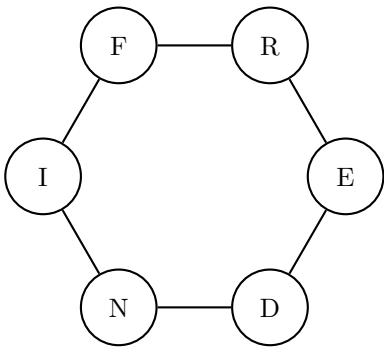

Rätsel Nummer 55

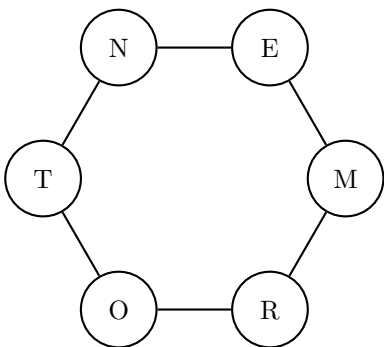

Rätsel Nummer 56

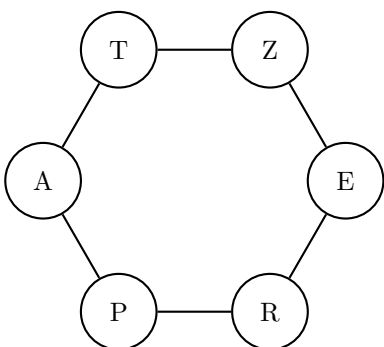

Rätsel Nummer 57

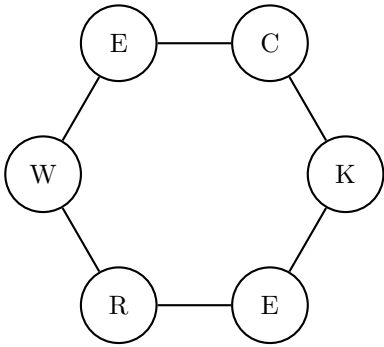

Rätsel Nummer 58

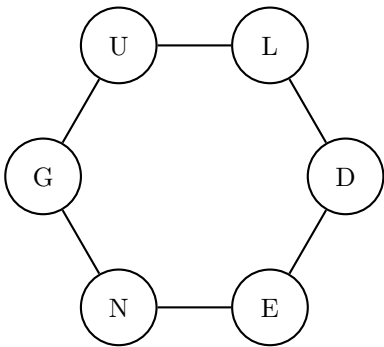

Rätsel Nummer 59

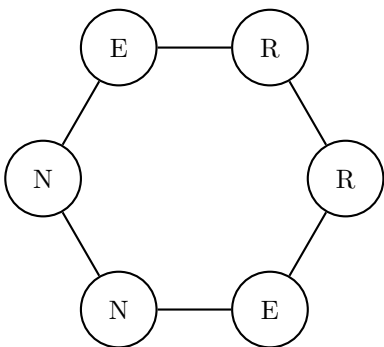

Rätsel Nummer 60

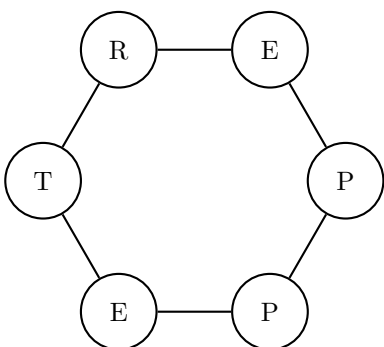

Rätsel Nummer 61

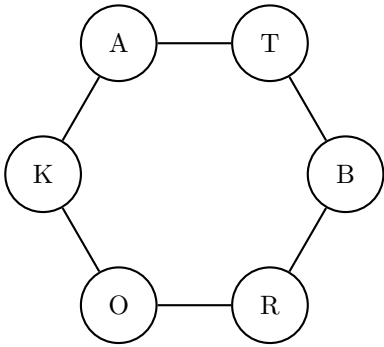

Rätsel Nummer 62

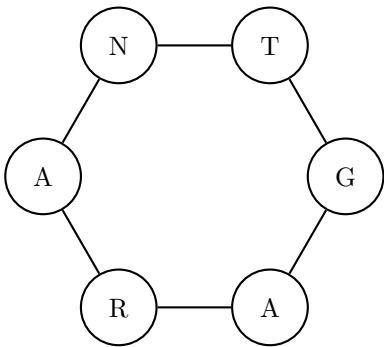

Rätsel Nummer 63

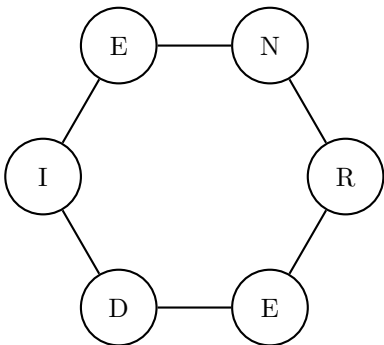

Rätsel Nummer 64

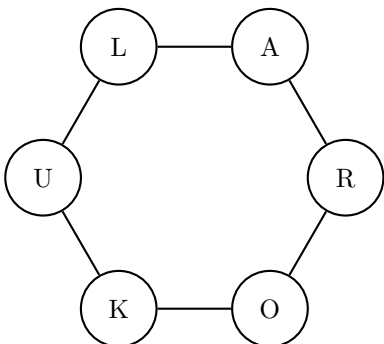

Rätsel Nummer 65

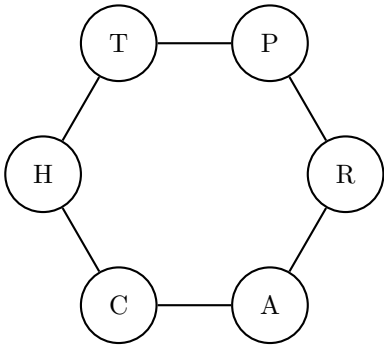

Rätsel Nummer 66

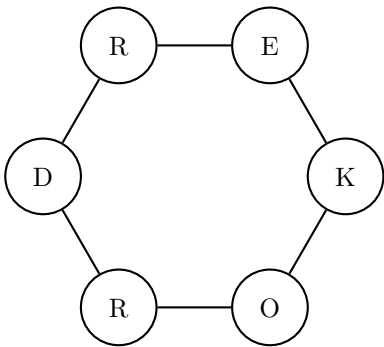

Rätsel Nummer 67

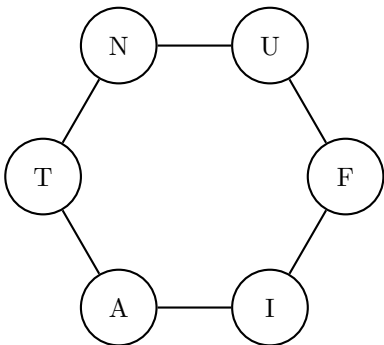

Rätsel Nummer 68

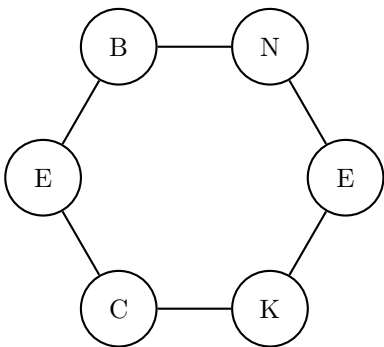

Rätsel Nummer 69

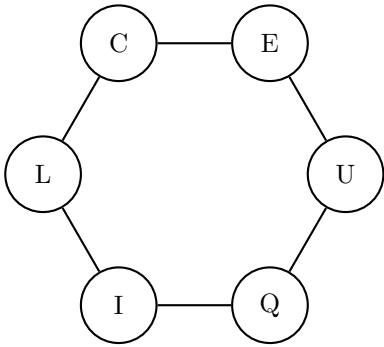

Rätsel Nummer 70

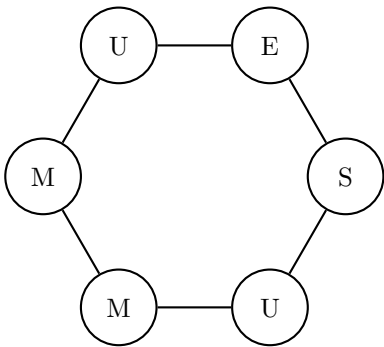

Rätsel Nummer 71

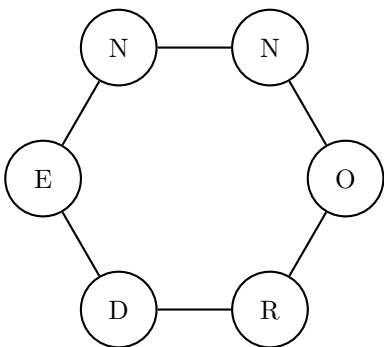

Rätsel Nummer 72

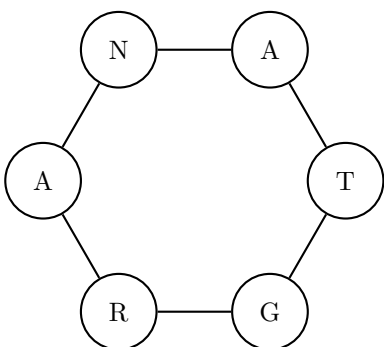

Rätsel Nummer 73

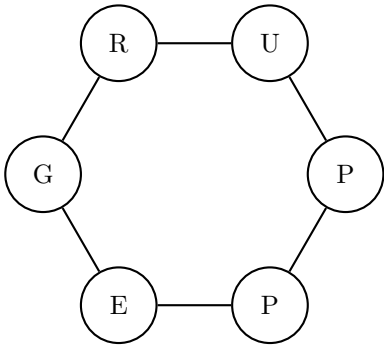

Rätsel Nummer 74

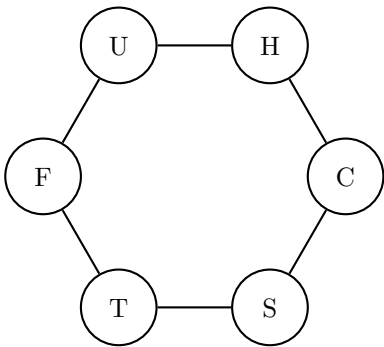

Rätsel Nummer 75

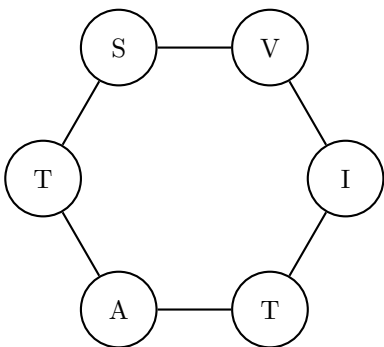

Rätsel Nummer 76

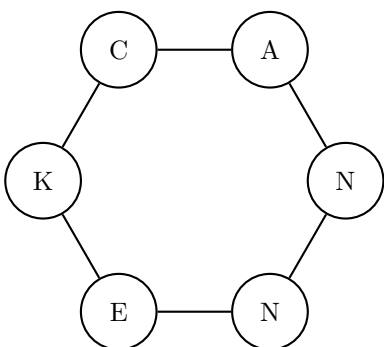

Rätsel Nummer 77

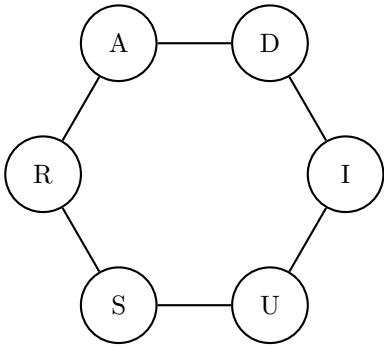

Rätsel Nummer 78

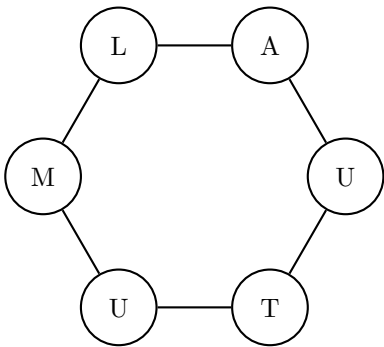

Rätsel Nummer 79

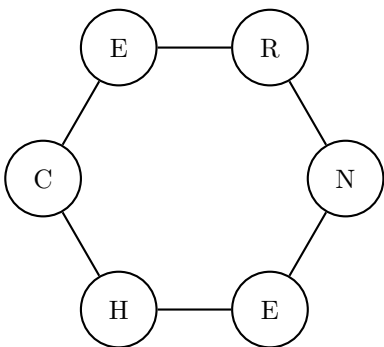

Rätsel Nummer 80

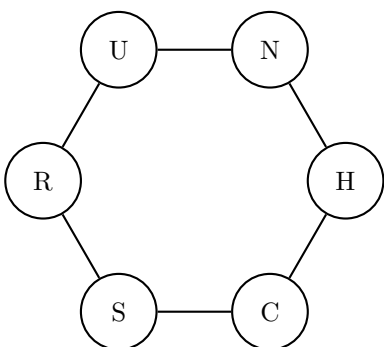

Rätsel Nummer 81

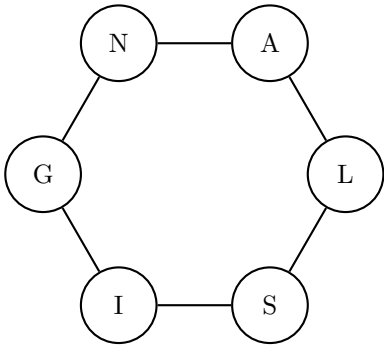

Rätsel Nummer 82

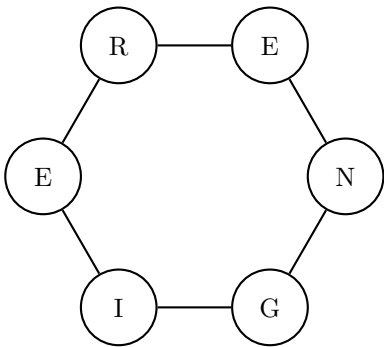

Rätsel Nummer 83

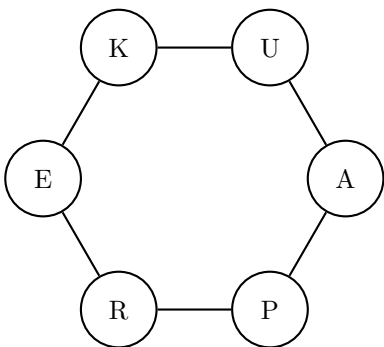

Rätsel Nummer 84

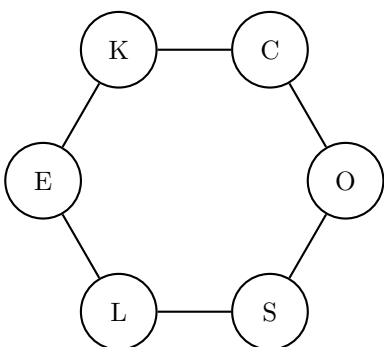



Rätsel Nummer 85

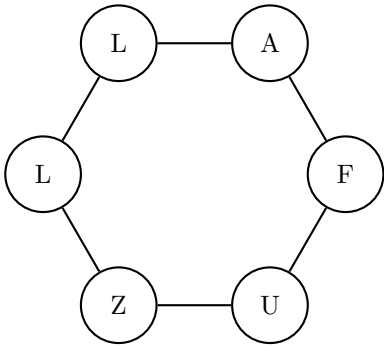

Rätsel Nummer 86

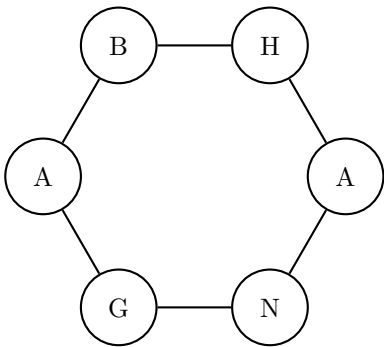

Rätsel Nummer 87

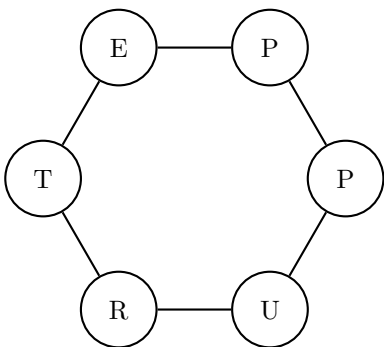

Rätsel Nummer 88

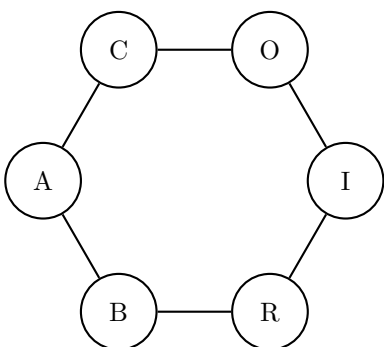

Rätsel Nummer 89

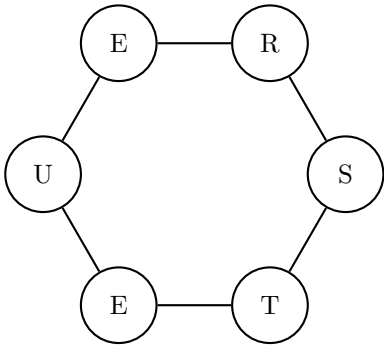

Rätsel Nummer 90

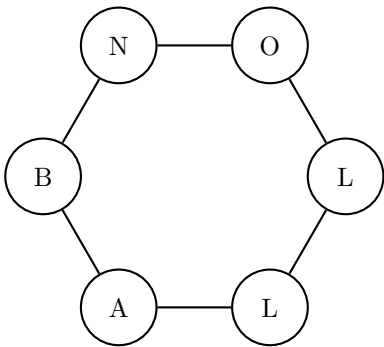

Rätsel Nummer 91

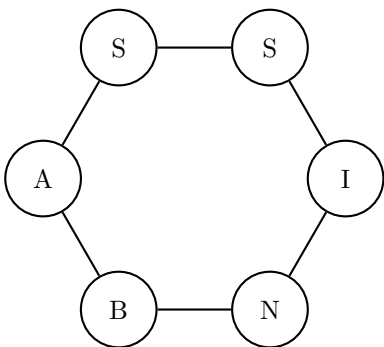

Rätsel Nummer 92

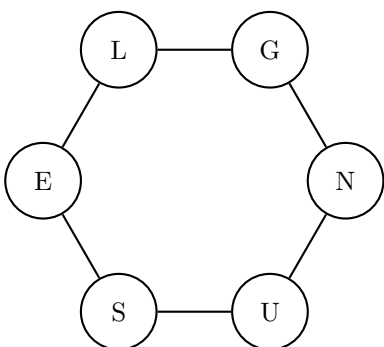

Rätsel Nummer 93

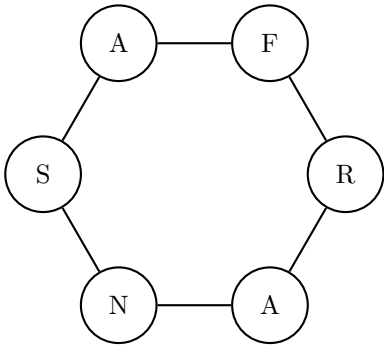

Rätsel Nummer 94

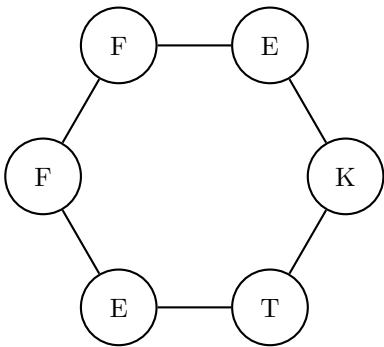

Rätsel Nummer 95

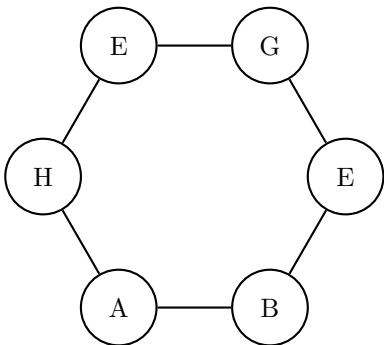

Rätsel Nummer 96

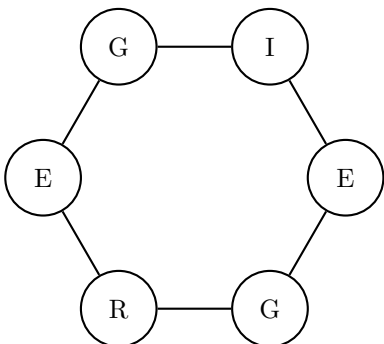

Rätsel Nummer 97

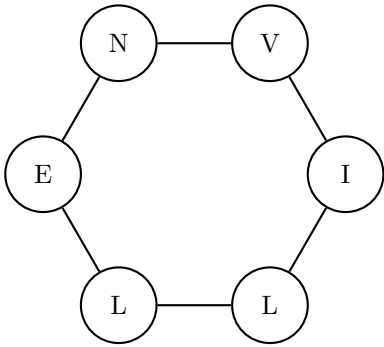

Rätsel Nummer 98

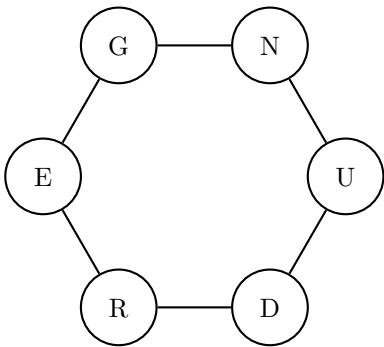

Rätsel Nummer 99

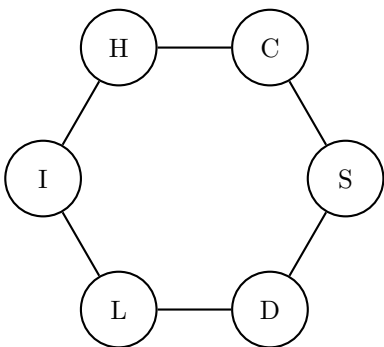

Rätsel Nummer 100

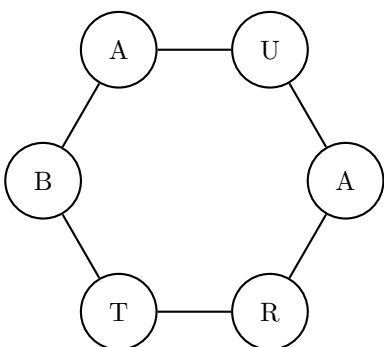

## Lösung

- |            |            |             |
|------------|------------|-------------|
| 1. BOHRER  | 34. SCHUTZ | 67. TAIFUN  |
| 2. PUFFER  | 35. HOCKEY | 68. BECKEN  |
| 3. VALIUM  | 36. LEGION | 69. CLIQUE  |
| 4. ABFLUG  | 37. GLASUR | 70. MUSEUM  |
| 5. GEBELL  | 38. KONTUR | 71. NORDEN  |
| 6. EPOCHE  | 39. MYSTIK | 72. GRANAT  |
| 7. BANDIT  | 40. SCHERZ | 73. GRUPPE  |
| 8. ORANGE  | 41. TEXTUR | 74. SCHUFT  |
| 9. DEKRET  | 42. TASCHE | 75. STATIV  |
| 10. JUSTIZ | 43. WETTER | 76. NACKEN  |
| 11. SCHWAN | 44. DACKEL | 77. RADIUS  |
| 12. TRUBEL | 45. KNOTEN | 78. UMLAUT  |
| 13. ZUCKER | 46. KOGNAK | 79. RECHEN  |
| 14. ERSATZ | 47. BISTUM | 80. SCHNUR  |
| 15. KASINO | 48. JODLER | 81. SIGNAL  |
| 16. VERBOT | 49. BEIRAT | 82. EIGNER  |
| 17. ANORAK | 50. BRUTTO | 83. PAUKER  |
| 18. ZYKLEN | 51. FAHRER | 84. SOCKEL  |
| 19. PFIFFE | 52. GNOSIS | 85. ZUFALL  |
| 20. GEHIRN | 53. BREZEL | 86. ABHANG  |
| 21. HAMMER | 54. FINDER | 87. TRUPPE  |
| 22. PALAST | 55. MENTOR | 88. CABRIO  |
| 23. RIEMEN | 56. PATZER | 89. STEUER  |
| 24. TRACHT | 57. WECKER | 90. BALLON  |
| 25. SCHEIT | 58. GULDEN | 91. BASSIN  |
| 26. KUPPEL | 59. RENNER | 92. LESUNG  |
| 27. KNACKS | 60. TREPPE | 93. SAFRAN  |
| 28. KNOSPE | 61. BROKAT | 94. EFFEKT  |
| 29. STRICK | 62. GARANT | 95. GEHABE  |
| 30. IRONIE | 63. NEIDER | 96. GEIGER  |
| 31. BETRAG | 64. OKULAR | 97. VILLEN  |
| 32. SKETCH | 65. PRACHT | 98. ERDUNG  |
| 33. BUTTER | 66. REKORD | 99. SCHILD  |
|            |            | 100. BAUART |