

100 Kreiswörter mit 6 Buchstaben Teil 10

Sascha Frank
www.kreiswort.de

12. Dezember 2012

Die gesuchten Wörter sind in einem Kreis aus Buchstaben versteckt. Das Wort kann vorwärts und rückwärts im Kreis stehen. Insgesamt gibt es 100 Rätsel zu lösen, am Ende gibt es eine kurze Lösung.

Mit freundlicher Unterstützung von:
Kinderzimmer Anastasia

Nail Design Freiburg

Flächen Umrechner

Gesucht

ABAKUS	FISTEL	RATION
ABKEHR	FLEGEL	REFLEX
ADONIS	FLOTTE	REGION
AFFEKT	GESANG	RELIEF
ANFLUG	GIGANT	RISIKO
ANTEIL	GLOSSE	RUBRIK
ANZAHL	HANGAR	SCHEIN
ARENEN	JARGON	SCHWUR
ARKADE	KAKTUS	SKONTO
ARNIKA	KARTEI	SONETT
ASBEST	KNEIPE	SOZIUS
ASPEKT	KONTRA	SPESEN
AUSTER	KRAGEN	SPHINX
AUSZUG	KREOLE	STATUE
BALSAM	KUPFER	STRANG
BARBAR	KUVERT	STREIT
BAROCK	LAGUNE	STRICH
BEHANG	LERCHE	TALENT
BEHELFF	LOGGIA	TICKET
BILLET	LUMPEN	TROPEN
BIOTOP	MACHER	ULTIMO
DIENER	MANEGE	UMLAUF
DISPUT	MERLIN	VAMPIR
DOPING	MODELL	VEKTOR
DRAMEN	MOSAIK	VISAGE
DYNAMO	NESTER	VISIER
EIGELB	NIVEAU	VORTAG
ELEGIE	NUANCE	WAGGON
ERTRAG	NUMMER	WANDEL
ETAPPE	PFANNE	WAPPEN
FILTER	PLASMA	WEILER
FINANZ	PODIUM	WUCHER
FIRMEN	RADIEN	WUNDER
		ZULAUF

Rätsel Nummer 1

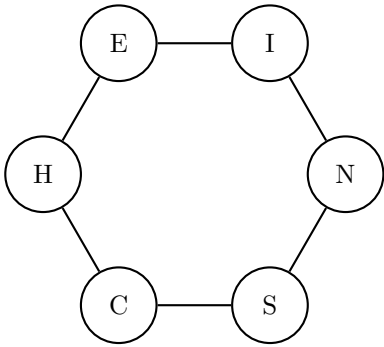

Rätsel Nummer 2

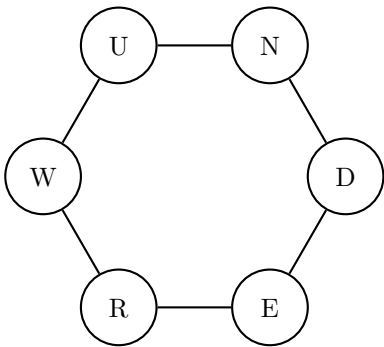

Rätsel Nummer 3

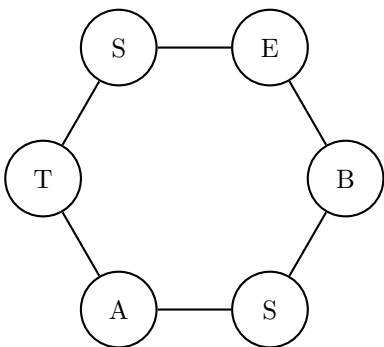

Rätsel Nummer 4

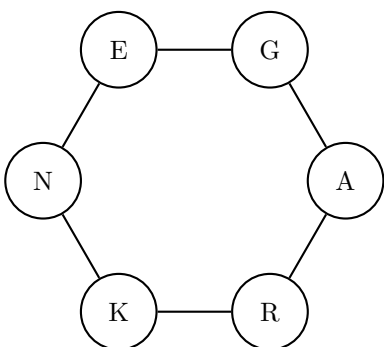

Rätsel Nummer 5

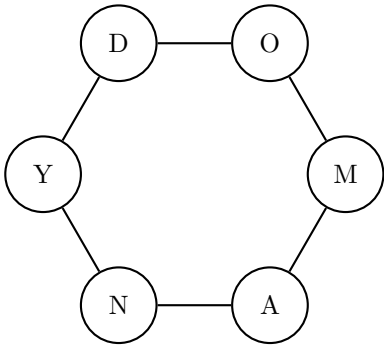

Rätsel Nummer 6

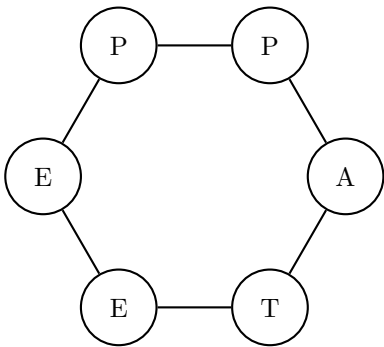

Rätsel Nummer 7

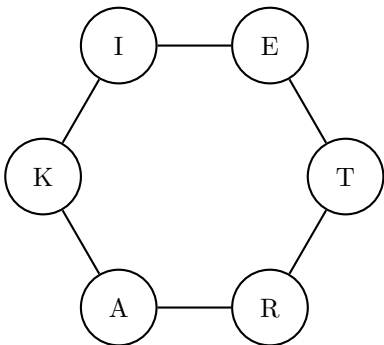

Rätsel Nummer 8

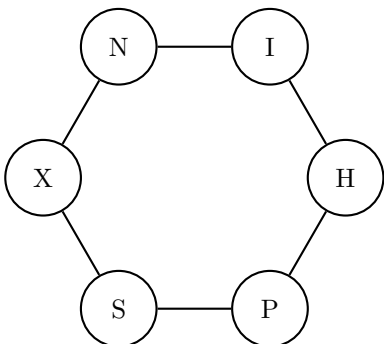

Rätsel Nummer 9

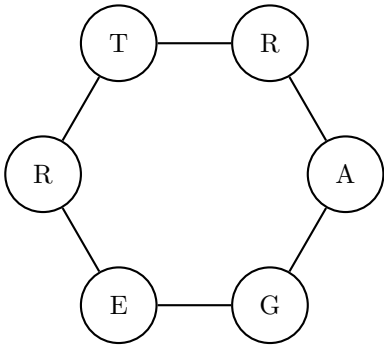

Rätsel Nummer 10

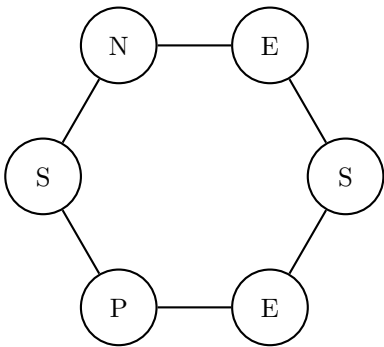

Rätsel Nummer 11

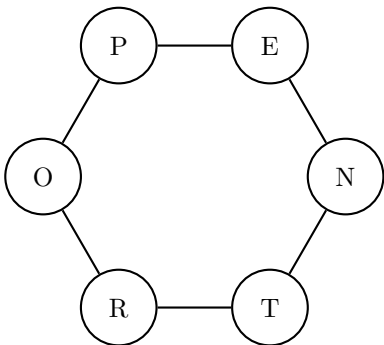

Rätsel Nummer 12

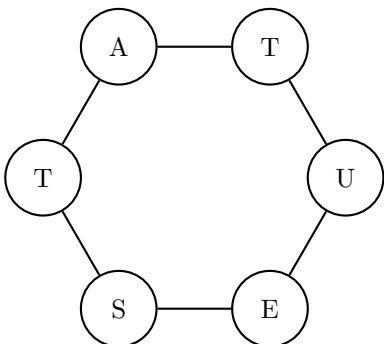

Rätsel Nummer 13

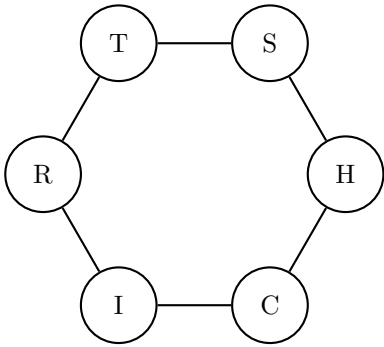

Rätsel Nummer 14

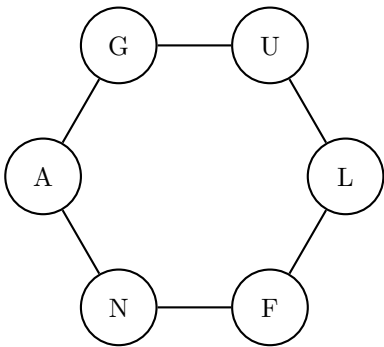

Rätsel Nummer 15

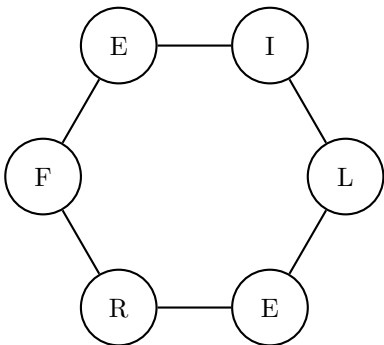

Rätsel Nummer 16

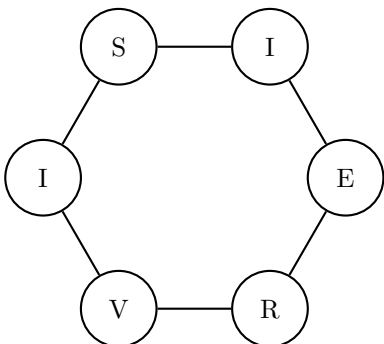

Rätsel Nummer 17

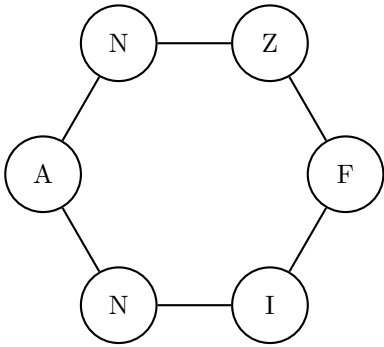

Rätsel Nummer 18

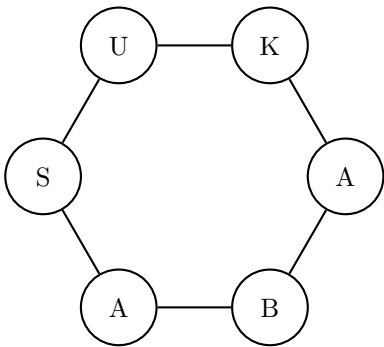

Rätsel Nummer 19

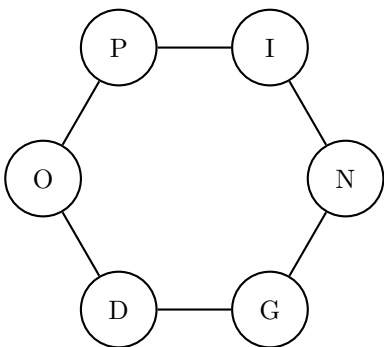

Rätsel Nummer 20

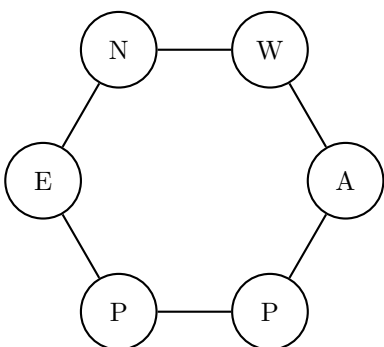

Rätsel Nummer 21

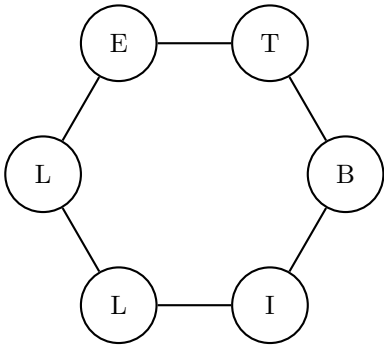

Rätsel Nummer 22

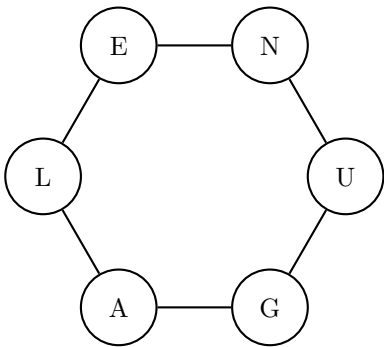

Rätsel Nummer 23

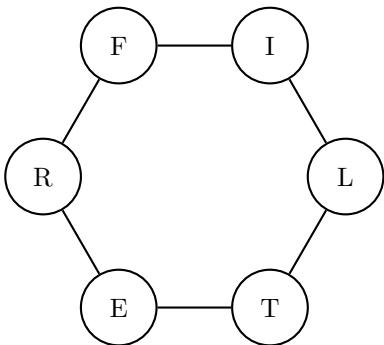

Rätsel Nummer 24

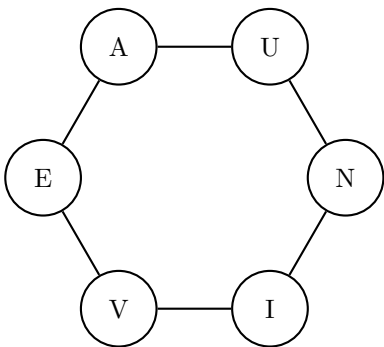

Rätsel Nummer 25

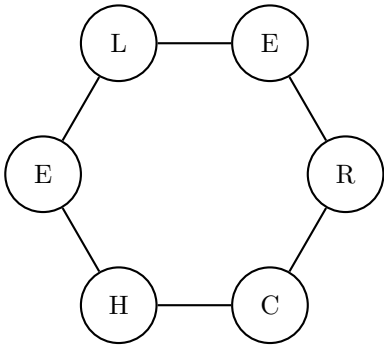

Rätsel Nummer 26

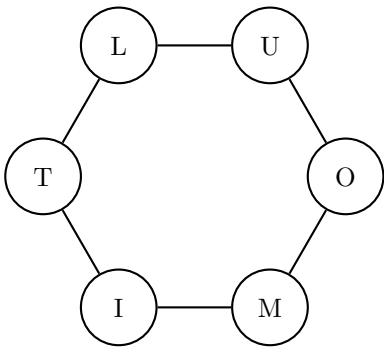

Rätsel Nummer 27

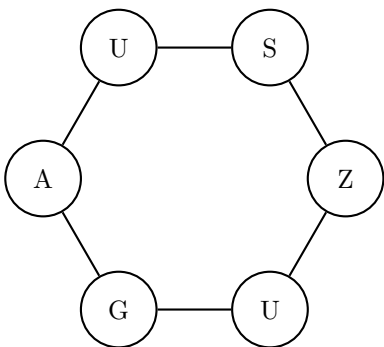

Rätsel Nummer 28

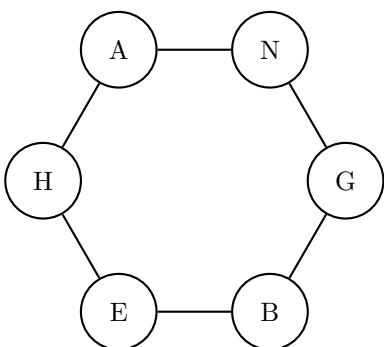

Rätsel Nummer 29

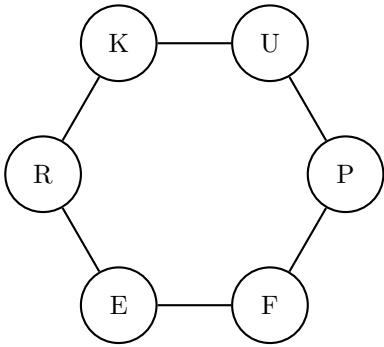

Rätsel Nummer 30

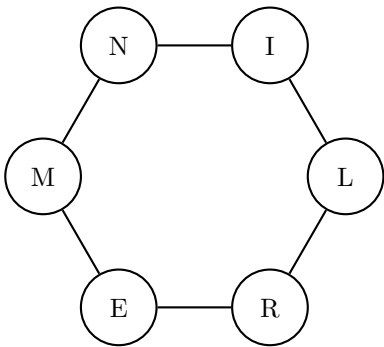

Rätsel Nummer 31

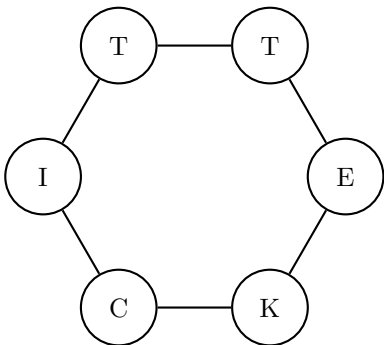

Rätsel Nummer 32

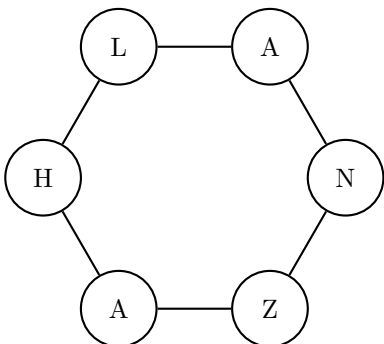

Rätsel Nummer 33

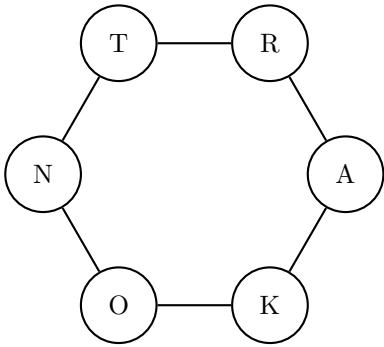

Rätsel Nummer 34

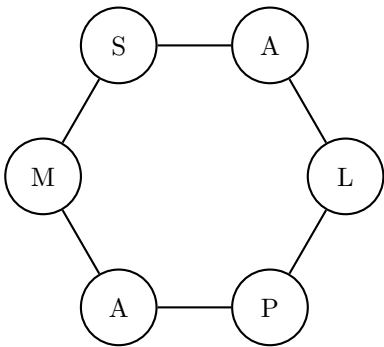

Rätsel Nummer 35

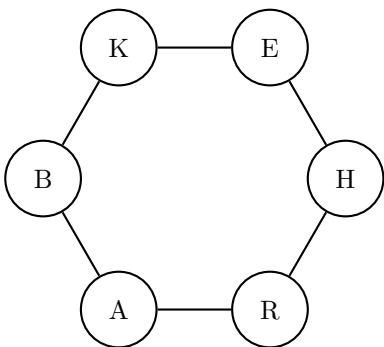

Rätsel Nummer 36

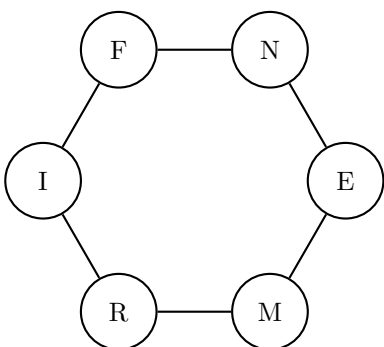

Rätsel Nummer 37

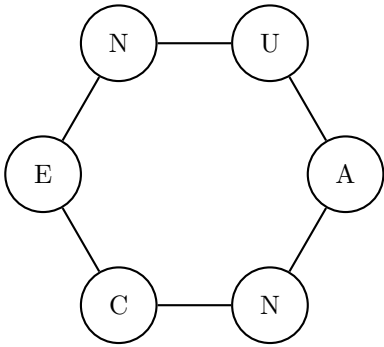

Rätsel Nummer 38

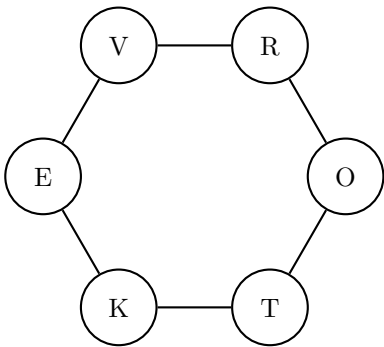

Rätsel Nummer 39

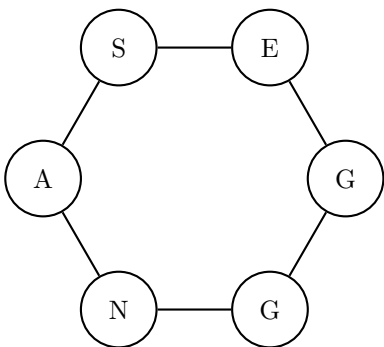

Rätsel Nummer 40

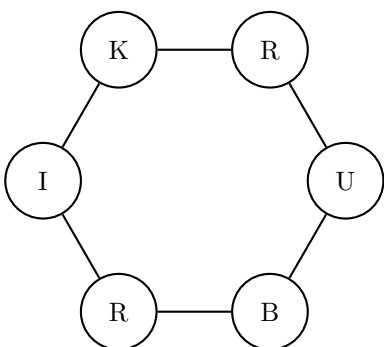

Rätsel Nummer 41

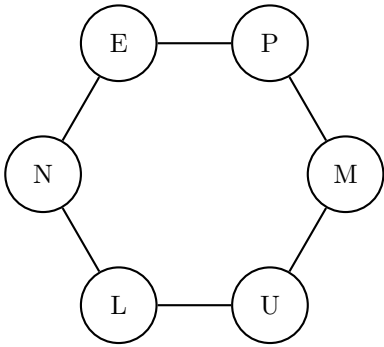

Rätsel Nummer 42

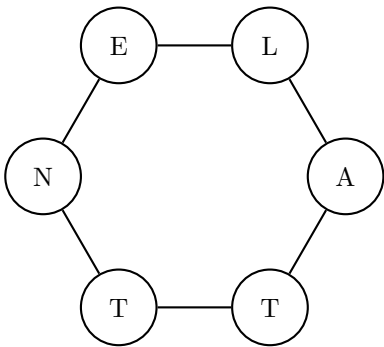

Rätsel Nummer 43

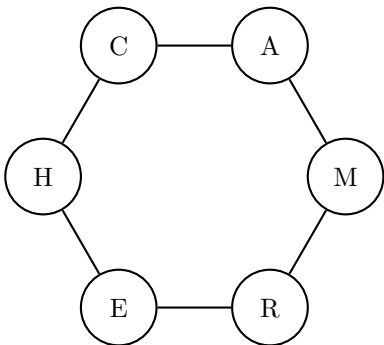

Rätsel Nummer 44

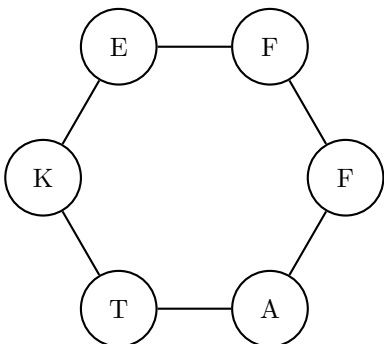

Rätsel Nummer 45

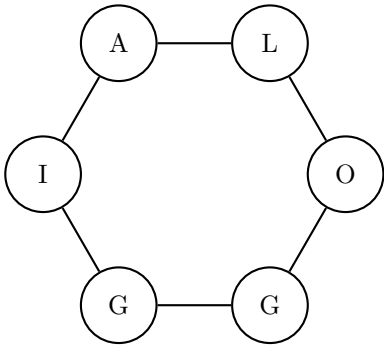

Rätsel Nummer 46

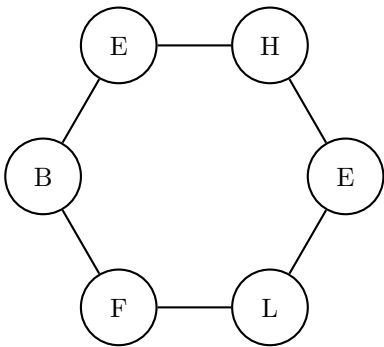

Rätsel Nummer 47

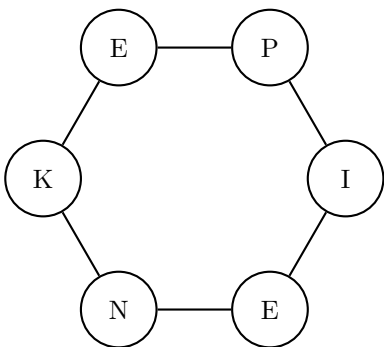

Rätsel Nummer 48

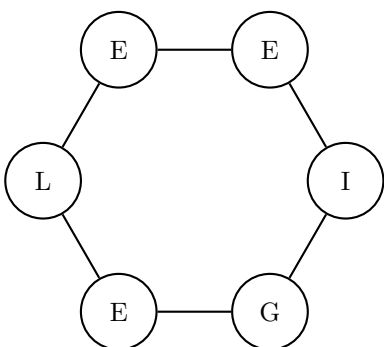

Rätsel Nummer 49

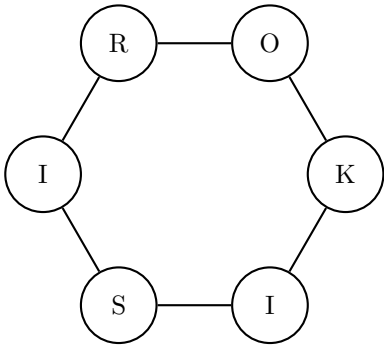

Rätsel Nummer 50

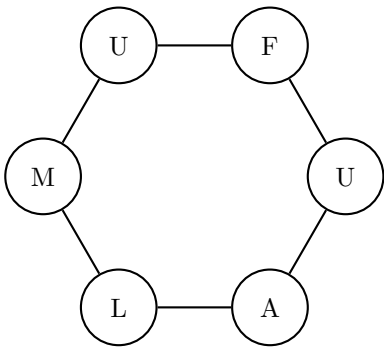

Rätsel Nummer 51

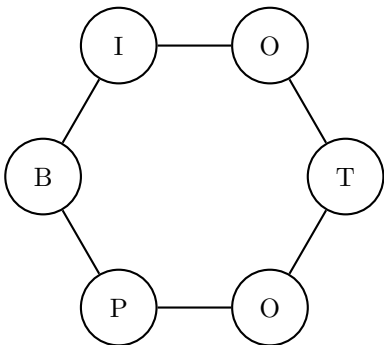

Rätsel Nummer 52

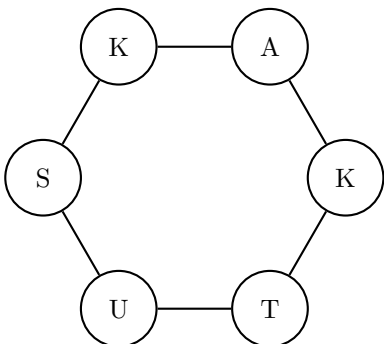

Rätsel Nummer 53

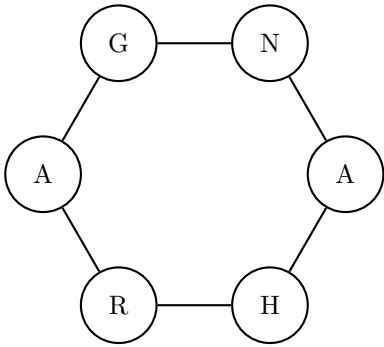

Rätsel Nummer 54

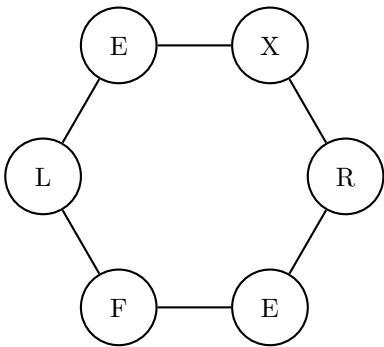

Rätsel Nummer 55

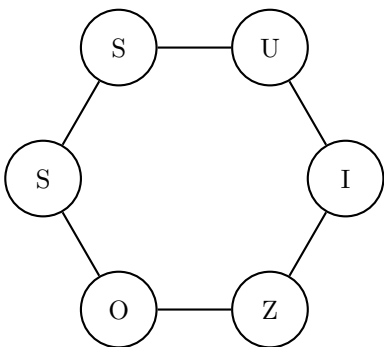

Rätsel Nummer 56

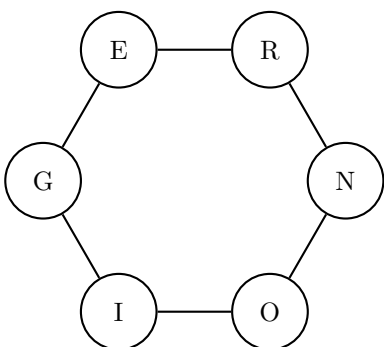

Rätsel Nummer 57

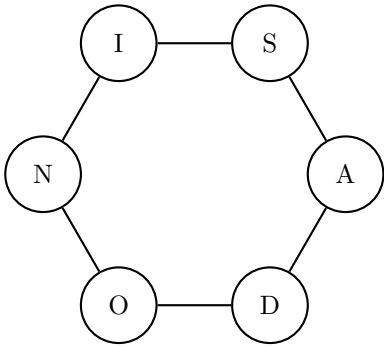

Rätsel Nummer 58

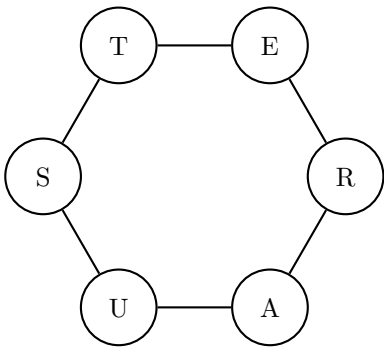

Rätsel Nummer 59

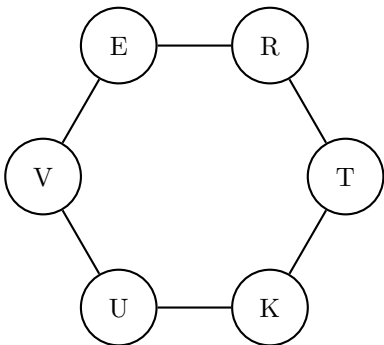

Rätsel Nummer 60

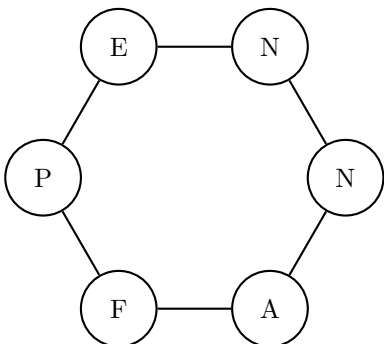

Rätsel Nummer 61

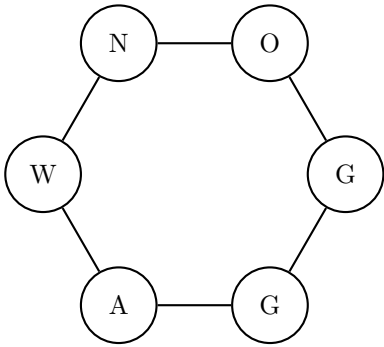

Rätsel Nummer 62

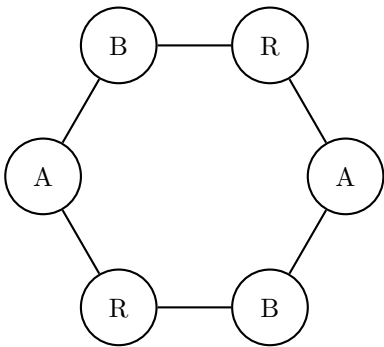

Rätsel Nummer 63

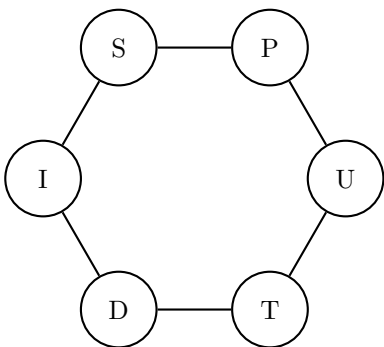

Rätsel Nummer 64

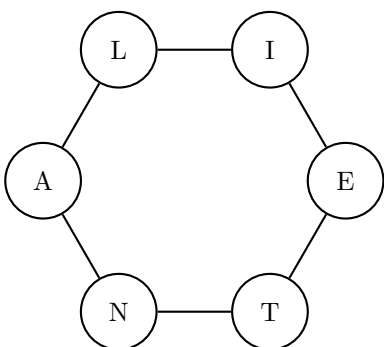

Rätsel Nummer 65

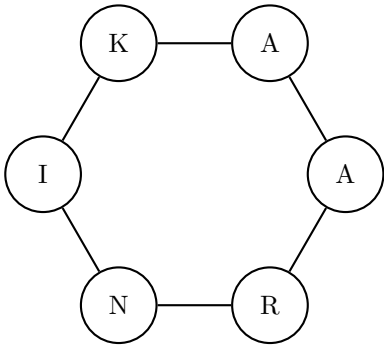

Rätsel Nummer 66

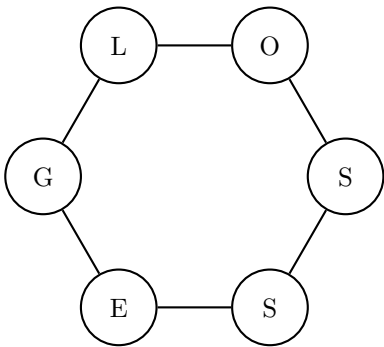

Rätsel Nummer 67

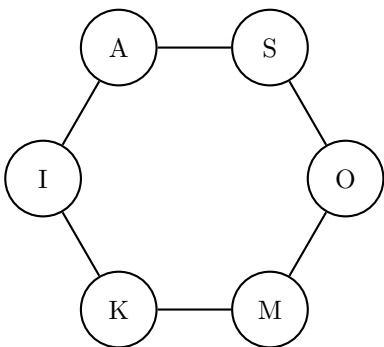

Rätsel Nummer 68

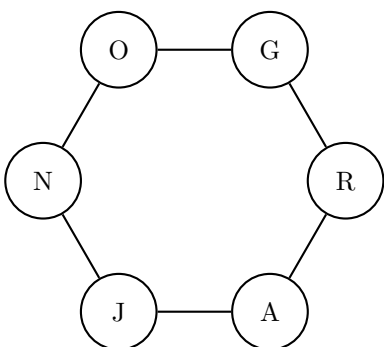

Rätsel Nummer 69

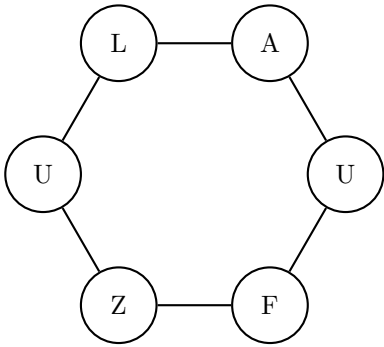

Rätsel Nummer 70

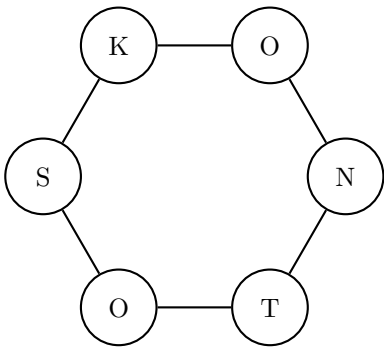

Rätsel Nummer 71

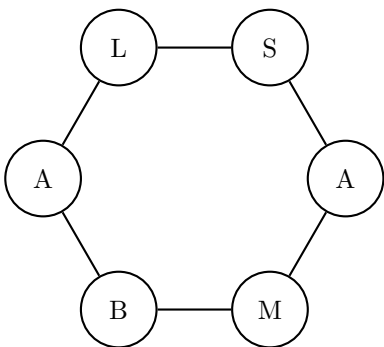

Rätsel Nummer 72

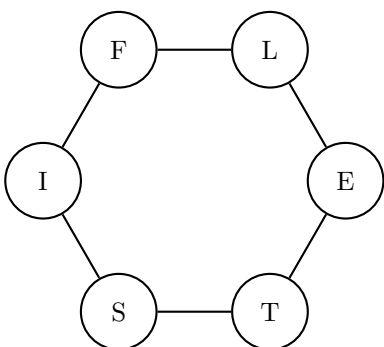

Rätsel Nummer 73

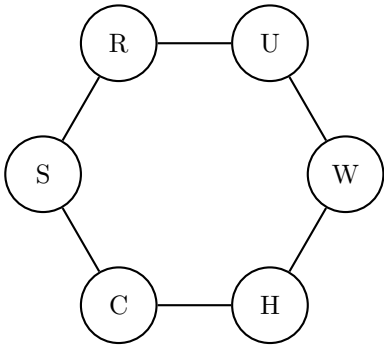

Rätsel Nummer 74

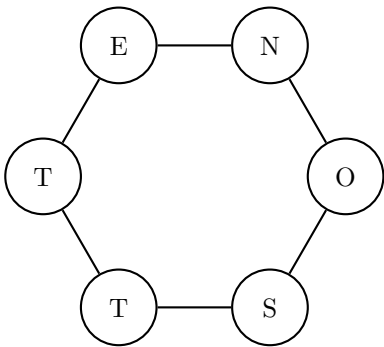

Rätsel Nummer 75

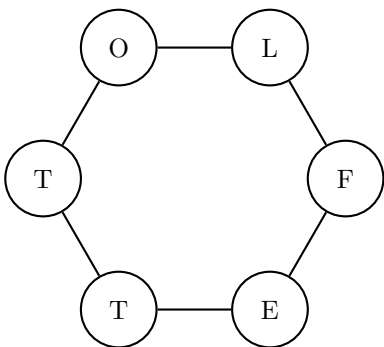

Rätsel Nummer 76

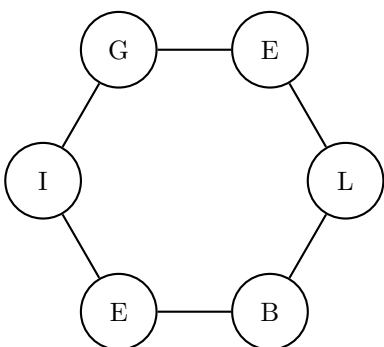

Rätsel Nummer 77

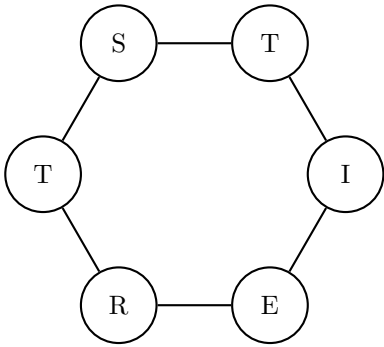

Rätsel Nummer 78

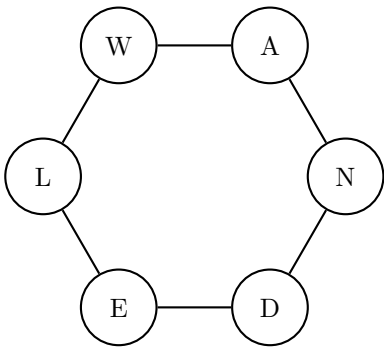

Rätsel Nummer 79

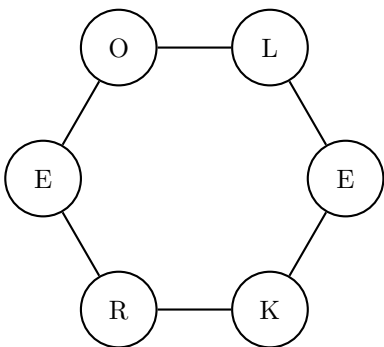

Rätsel Nummer 80

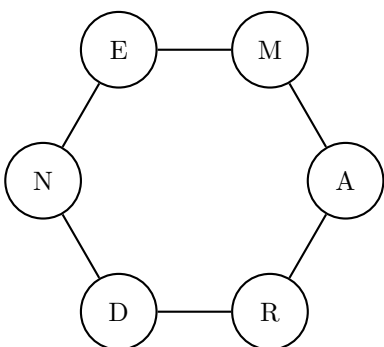

Rätsel Nummer 81

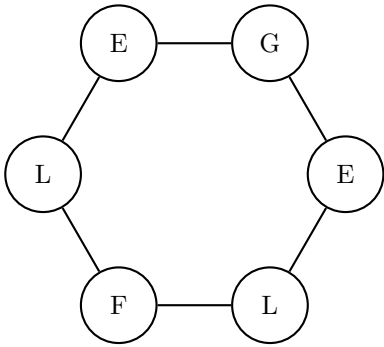

Rätsel Nummer 82

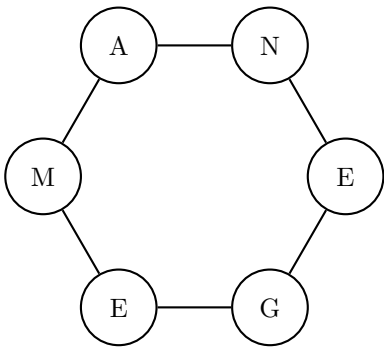

Rätsel Nummer 83

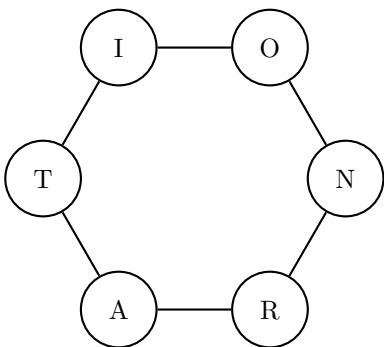

Rätsel Nummer 84

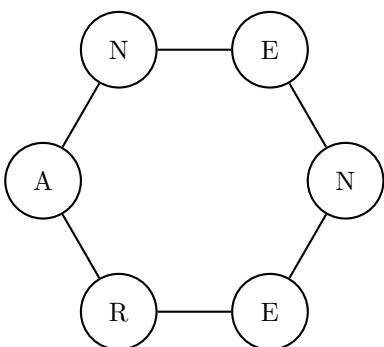

Rätsel Nummer 85

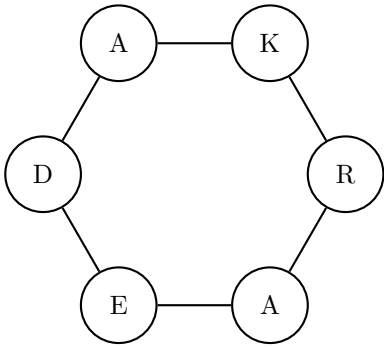

Rätsel Nummer 86

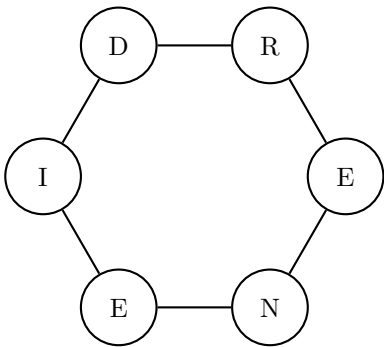

Rätsel Nummer 87

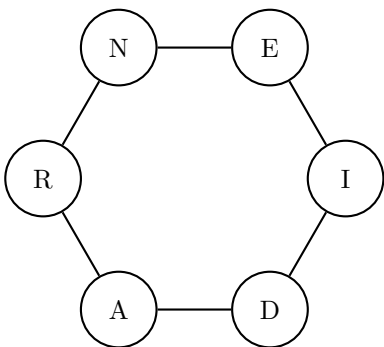

Rätsel Nummer 88

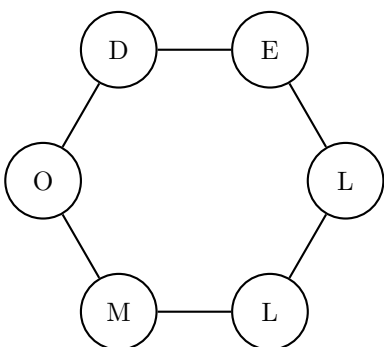

Rätsel Nummer 89

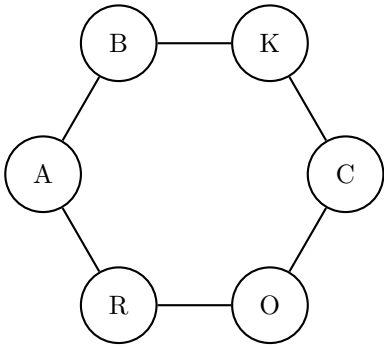

Rätsel Nummer 90

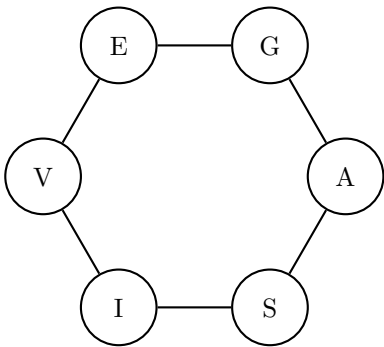

Rätsel Nummer 91

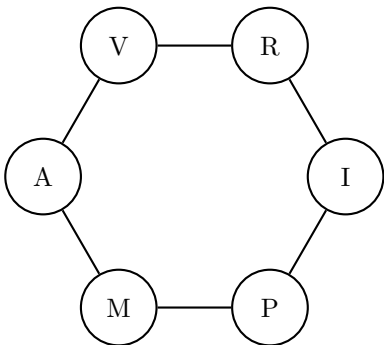

Rätsel Nummer 92

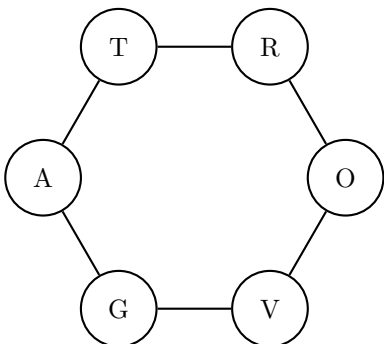

Rätsel Nummer 93

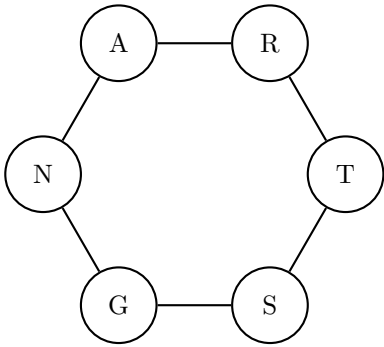

Rätsel Nummer 94

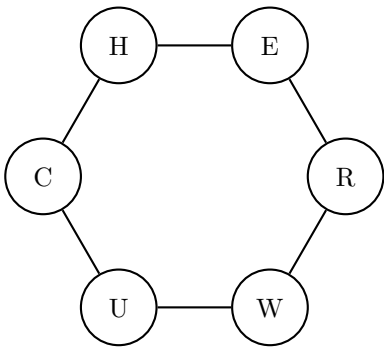

Rätsel Nummer 95

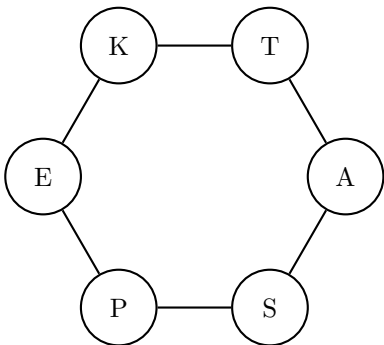

Rätsel Nummer 96

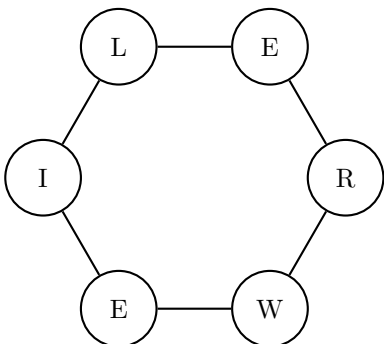

Rätsel Nummer 97

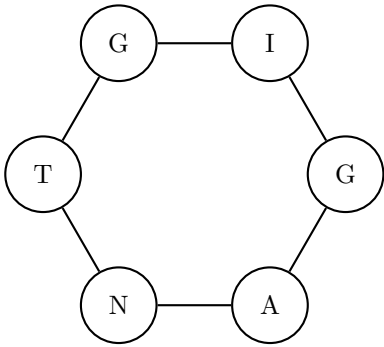

Rätsel Nummer 98

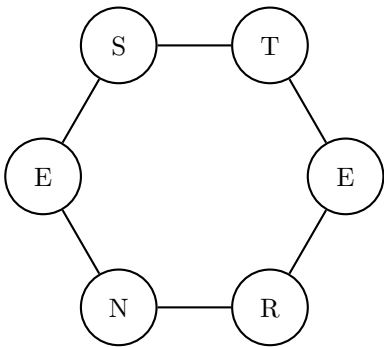

Rätsel Nummer 99

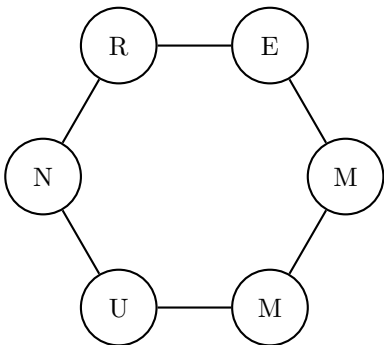

Rätsel Nummer 100

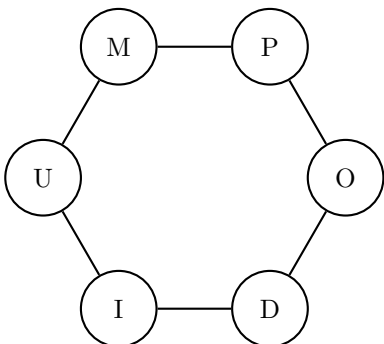

Lösung

1.SCHEIN	34.PLASMA	67.MOSAIK
2.WUNDER	35.ABKEHR	68.JARGON
3.ASBEST	36.FIRMEN	69.ZULAUF
4.KRAGEN	37.NUANCE	70.SKONTO
5.DYNAMO	38.VEKTOR	71.BALSAM
6.ETAPPE	39.GESANG	72.FISTEL
7.KARTEI	40.RUBRIK	73.SCHWUR
8.SPHINX	41.LUMPEN	74.SONETT
9.ERTRAG	42.TALENT	75.FLOTTE
10.SPESEN	43.MACHER	76.EIGELB
11.TROPEN	44.AFFEKT	77.STREIT
12.STATUE	45.LOGGIA	78.WANDEL
13.STRICH	46.BEHELF	79.KREOLE
14.ANFLUG	47.KNEIPE	80.DRAMEN
15.RELIEF	48.ELEGIE	81.FLEGEL
16.VISIER	49.RISIKO	82.MANEGE
17.FINANZ	50.UMLAUF	83.RATION
18.ABAKUS	51.BIOTOP	84.ARENEN
19.DOPING	52.KAKTUS	85.ARKADE
20.WAPPEN	53.HANGAR	86.DIENER
21.BILLET	54.REFLEX	87.RADIEN
22.LAGUNE	55.SOZIUS	88.MODELL
23.FILTER	56.REGION	89.BAROCK
24.NIVEAU	57.ADONIS	90.VISAGE
25.LERCHE	58.AUSTER	91.VAMPIR
26.ULTIMO	59.KUVERT	92.VORTAG
27.AUSZUG	60.PFANNE	93.STRANG
28.BEHANG	61.WAGGON	94.WUCHER
29.KUPFER	62.BARBAR	95.ASPEKT
30.MERLIN	63.DISPUT	96.WEILER
31.TICKET	64.ANTEIL	97.GIGANT
32.ANZAHL	65.ARNKA	98.NESTER
33.KONTRA	66.GLOSSE	99.NUMMER
		100.PODIUM