

100 Kreiswörter mit 6 Buchstaben Teil 2

Sascha Frank
www.kreiswort.de

12. Dezember 2012

Die gesuchten Wörter sind in einem Kreis aus Buchstaben versteckt. Das Wort kann vorwärts und rückwärts im Kreis stehen. Insgesamt gibt es 100 Rätsel zu lösen, am Ende gibt es eine kurze Lösung.

Mit freundlicher Unterstützung von:

Autobett Kinderzimmer Sport V3 in weiß

Sugaring Freiburg

Prozentrechner

Gesucht

ABITUR	GRAZIE	PIRSCH
AKTEUR	HAMMEL	PODIEN
AKTION	HEBUNG	PROFIL
AKZEPT	HEKTAR	PUZZLE
ANGLER	HEROIN	RADIAN
ANLAUF	INNERN	RAHMEN
AUFBAU	JANUAR	REBELL
AUSRUF	JUGEND	REGLER
BAISER	KARIES	REIGEN
BALKEN	KELLER	SAISON
BENGEL	KIEFER	SATIRE
BIETER	KNICKS	SCHEMA
CHARTA	KNOLLE	SCHREI
CHEMIE	KOCHER	SICHEL
DOTTER	KOSAKE	SOMMER
EGOIST	KRALLE	SPAGAT
ESELEI	KRESSE	STEREO
EXPORT	KULANZ	STUNDE
FABRIK	KURBEL	TATORT
FOLTER	KURIER	TERROR
FRAGER	LAYOUT	TRAPEZ
FRESKE	MAKLER	TRAUER
GALOPP	MANGAN	TRESOR
GARTEN	METALL	TRIBUN
GEBIET	METEOR	TURNER
GEGEND	MIKADO	VALUTA
GEMACH	NATION	VASALL
GESETZ	NICHTE	VORRAT
GEWAND	NICKEL	VORZUG
GEWIRR	NOMADE	WIESEL
GITTER	OBDACH	WIMPER
GONDEL	PENSUM	WINKEL
GRAFIK	PHYSIK	WURZEL
		ZUNDER

Rätsel Nummer 1

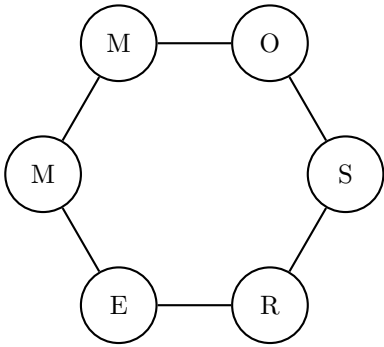

Rätsel Nummer 2

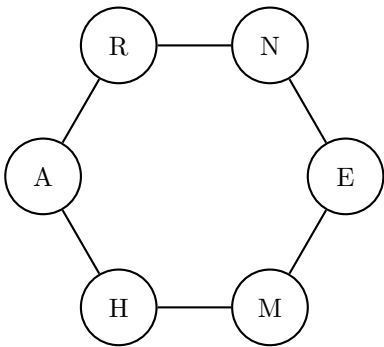

Rätsel Nummer 3

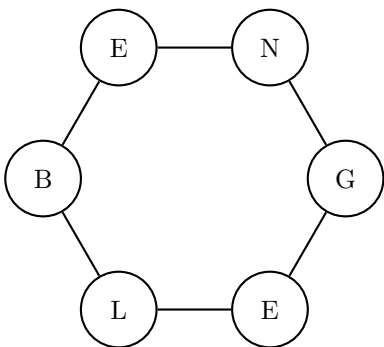

Rätsel Nummer 4

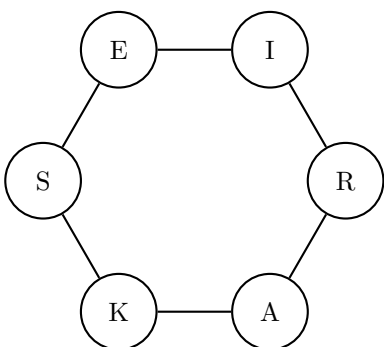

Rätsel Nummer 5

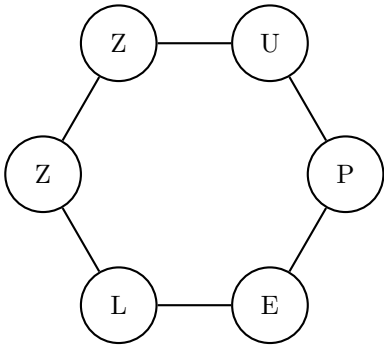

Rätsel Nummer 6

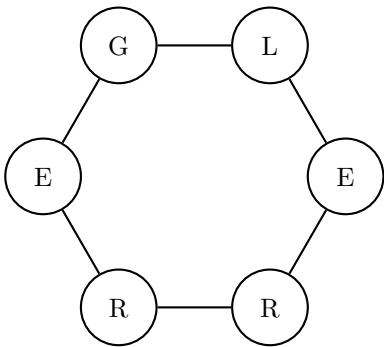

Rätsel Nummer 7

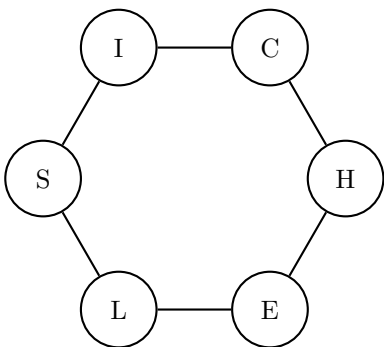

Rätsel Nummer 8

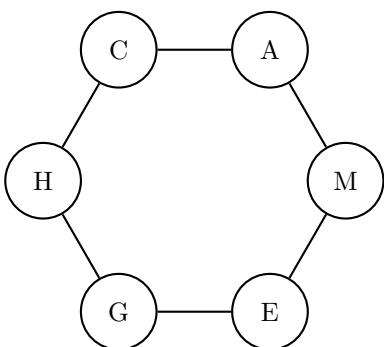

Rätsel Nummer 9

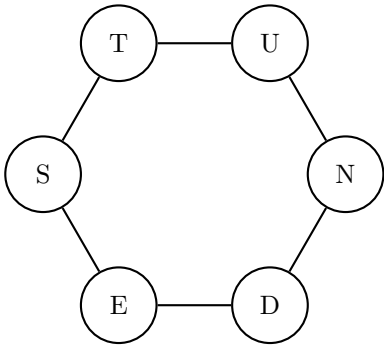

Rätsel Nummer 10

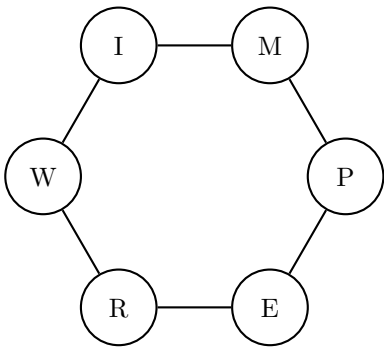

Rätsel Nummer 11

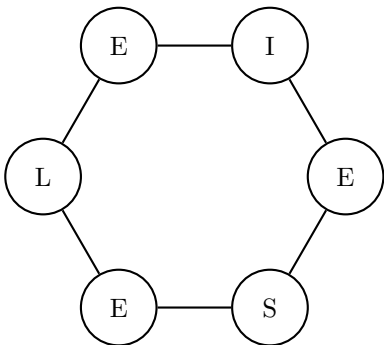

Rätsel Nummer 12

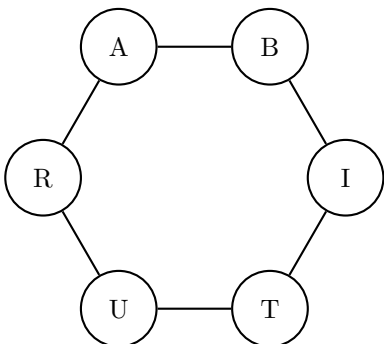

Rätsel Nummer 13

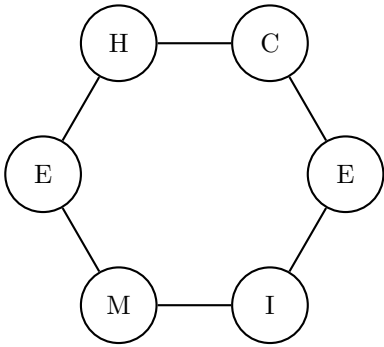

Rätsel Nummer 14

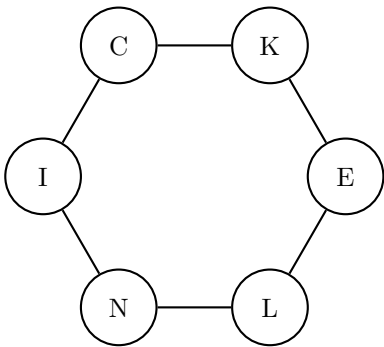

Rätsel Nummer 15

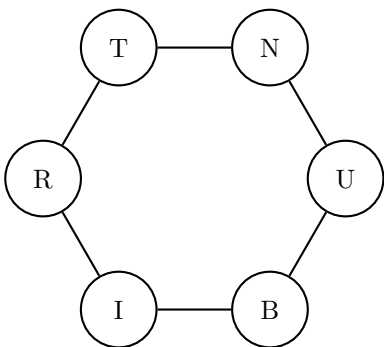

Rätsel Nummer 16

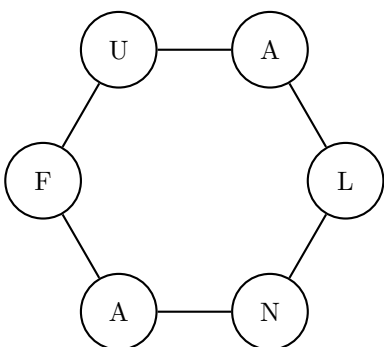

Rätsel Nummer 17

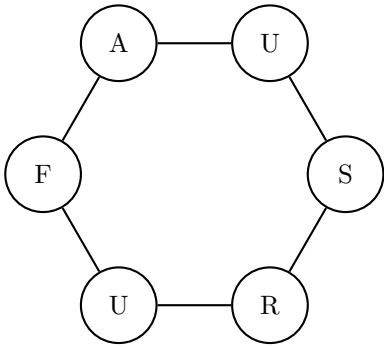

Rätsel Nummer 18

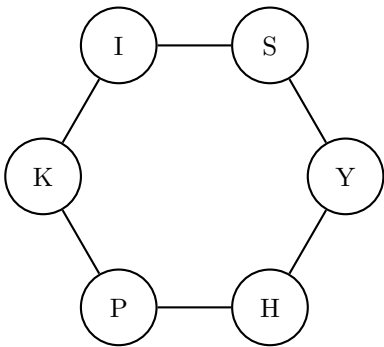

Rätsel Nummer 19

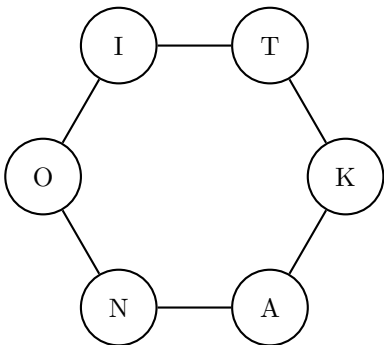

Rätsel Nummer 20

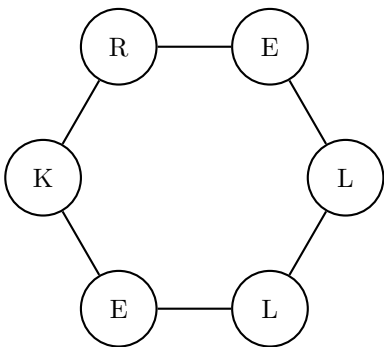

Rätsel Nummer 21

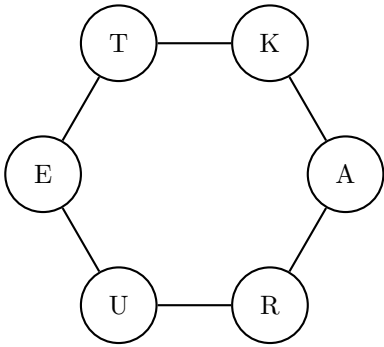

Rätsel Nummer 22

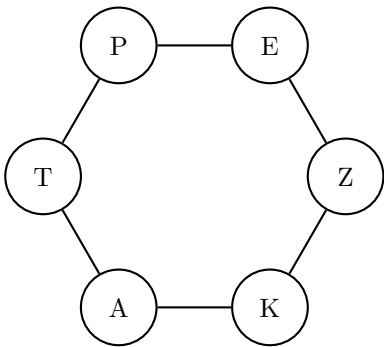

Rätsel Nummer 23

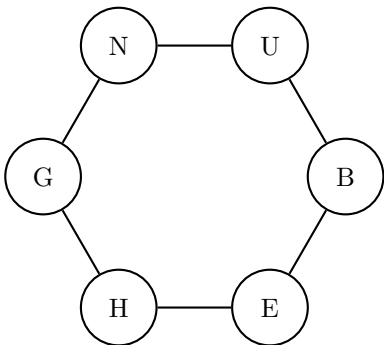

Rätsel Nummer 24

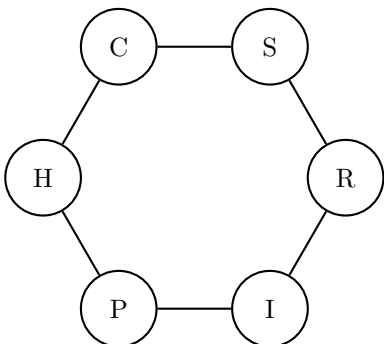

Rätsel Nummer 25

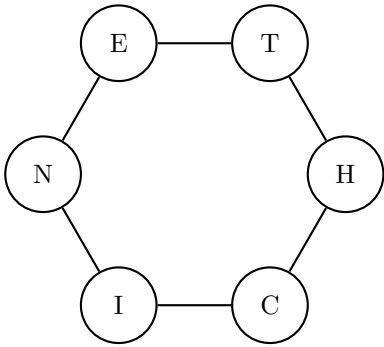

Rätsel Nummer 26

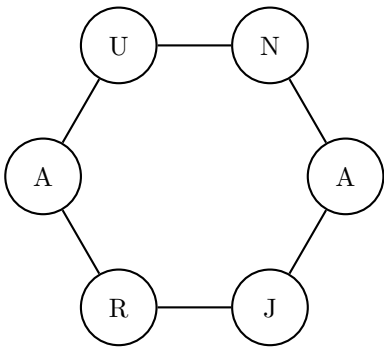

Rätsel Nummer 27

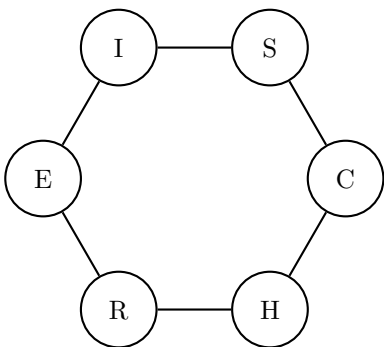

Rätsel Nummer 28

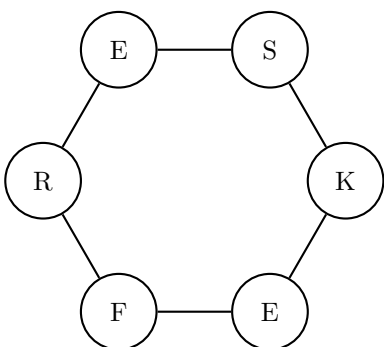

Rätsel Nummer 29

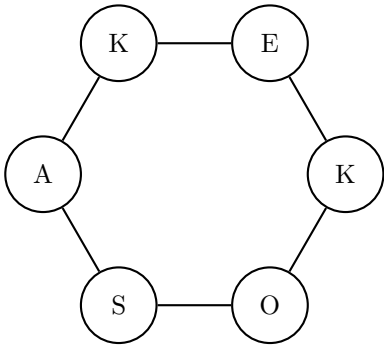

Rätsel Nummer 30

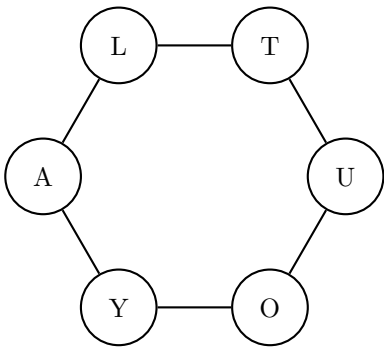

Rätsel Nummer 31

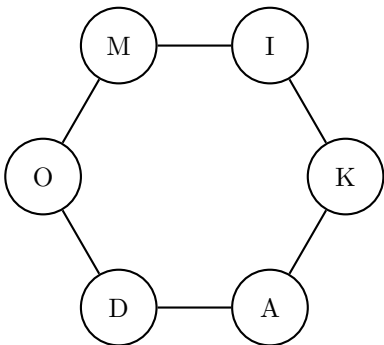

Rätsel Nummer 32

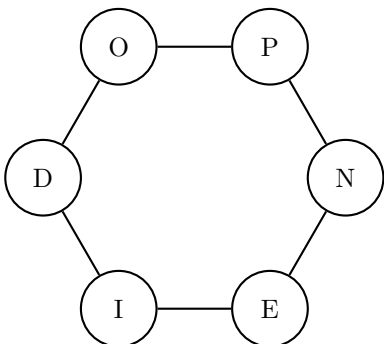

Rätsel Nummer 33

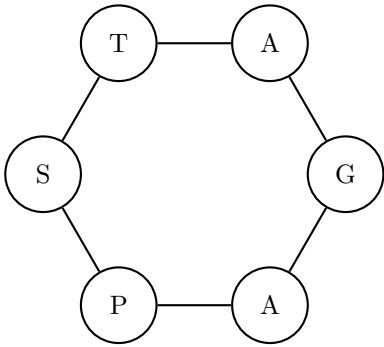

Rätsel Nummer 34

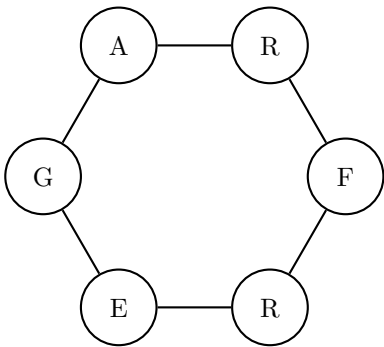

Rätsel Nummer 35

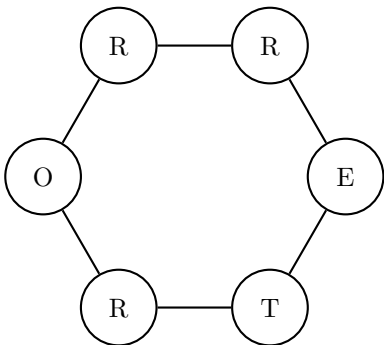

Rätsel Nummer 36

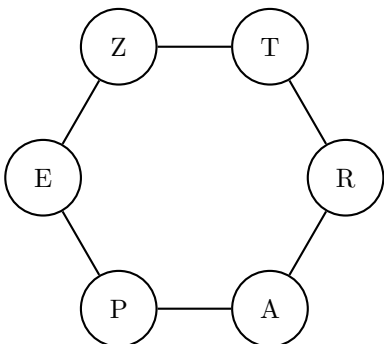

Rätsel Nummer 37

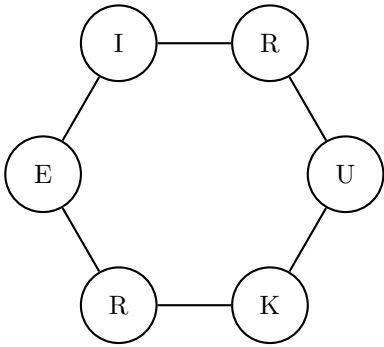

Rätsel Nummer 38

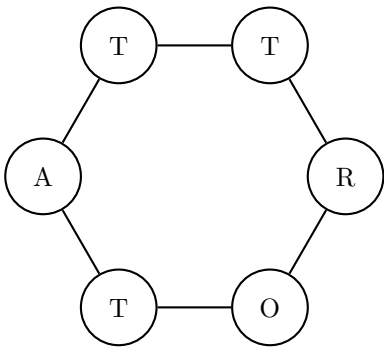

Rätsel Nummer 39

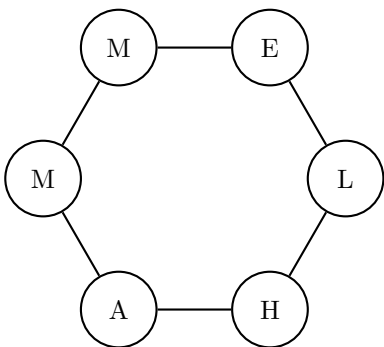

Rätsel Nummer 40

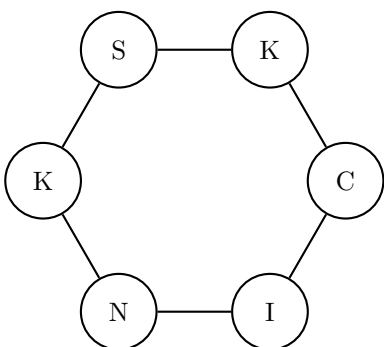

Rätsel Nummer 41

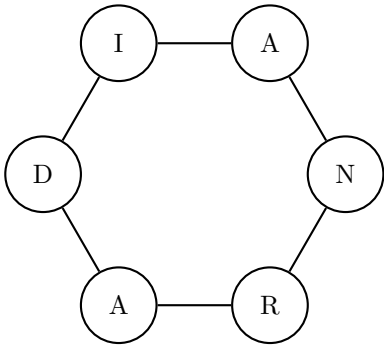

Rätsel Nummer 42

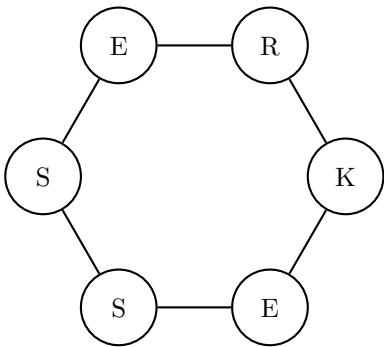

Rätsel Nummer 43

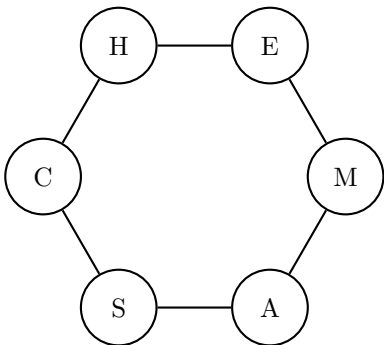

Rätsel Nummer 44

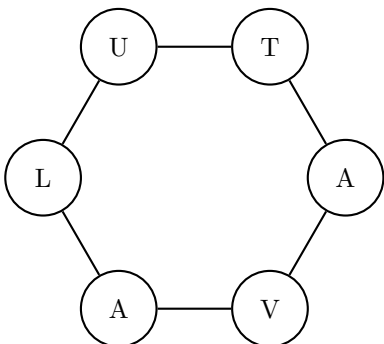

Rätsel Nummer 45

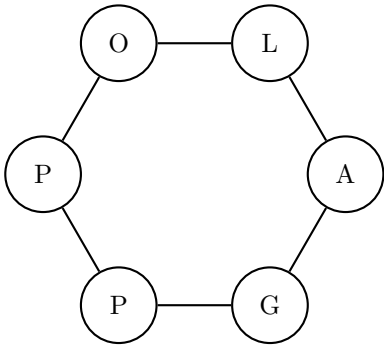

Rätsel Nummer 46

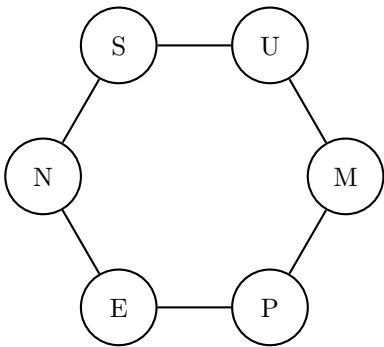

Rätsel Nummer 47

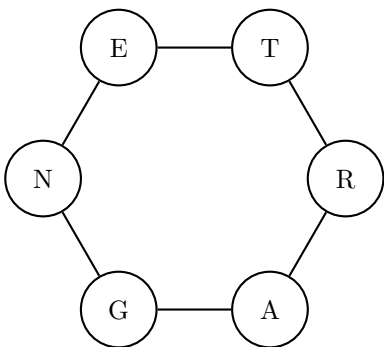

Rätsel Nummer 48

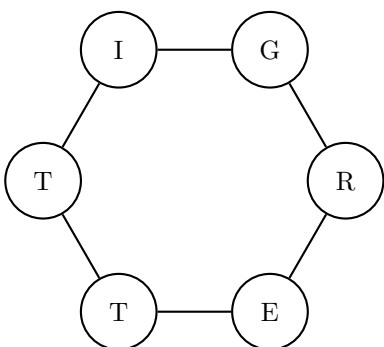

Rätsel Nummer 49

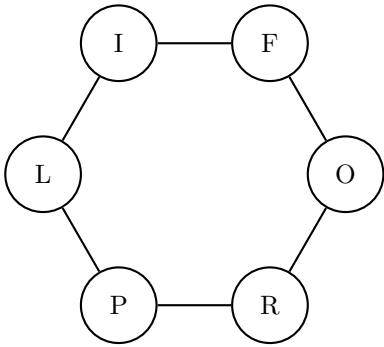

Rätsel Nummer 50

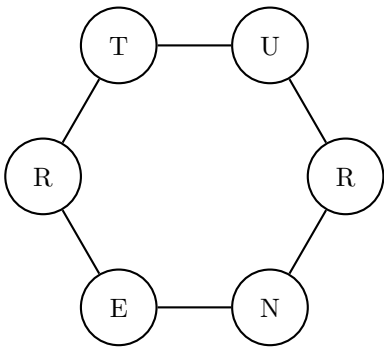

Rätsel Nummer 51

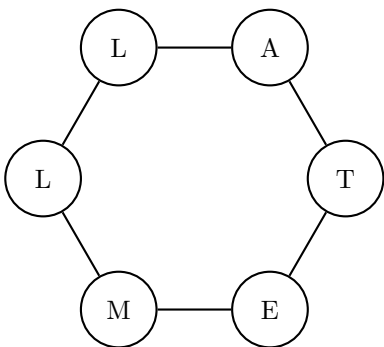

Rätsel Nummer 52

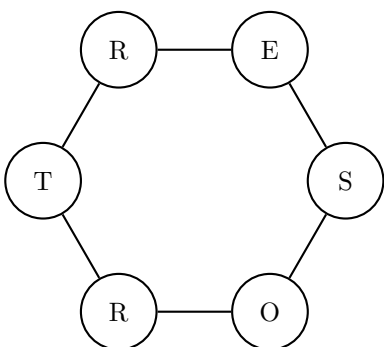

Rätsel Nummer 53

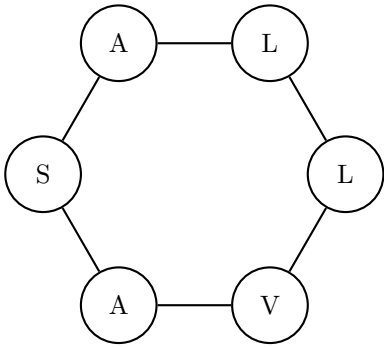

Rätsel Nummer 54

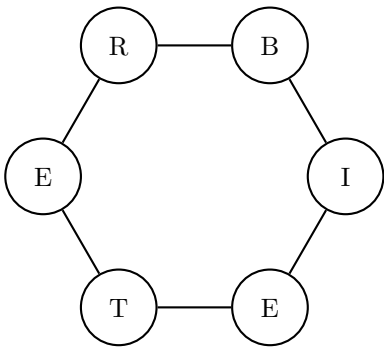

Rätsel Nummer 55

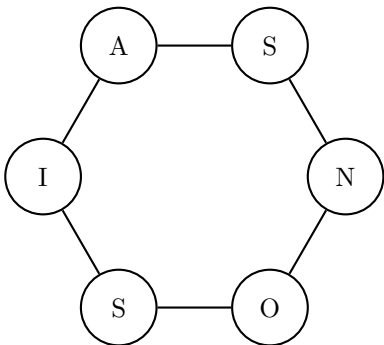

Rätsel Nummer 56

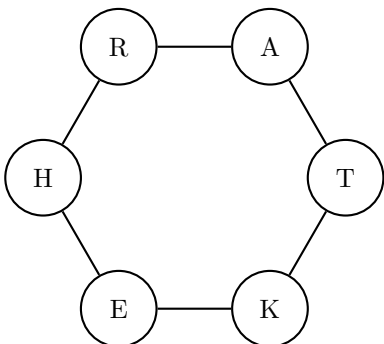

Rätsel Nummer 57

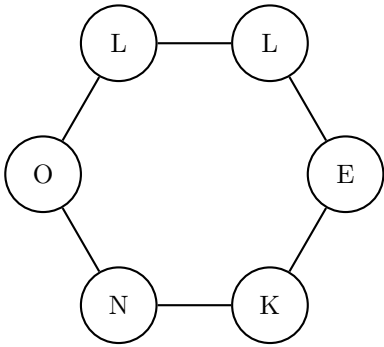

Rätsel Nummer 58

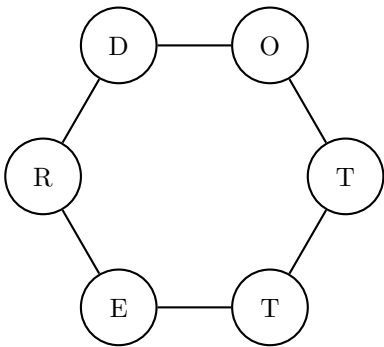

Rätsel Nummer 59

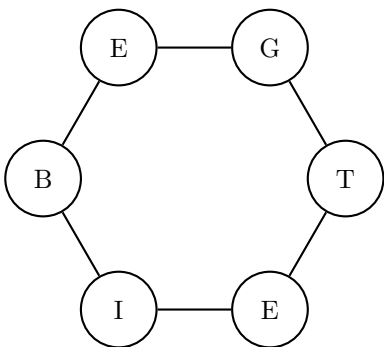

Rätsel Nummer 60

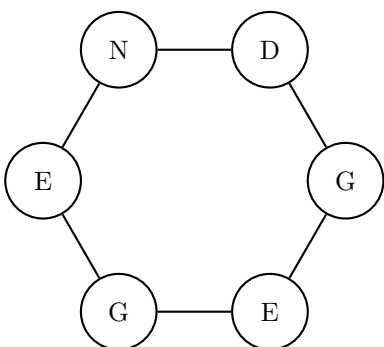

Rätsel Nummer 61

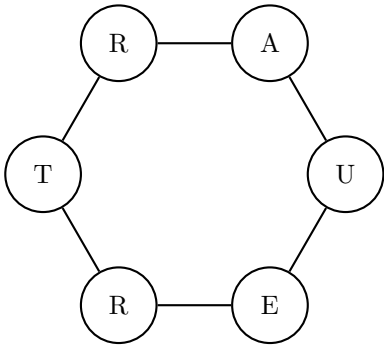

Rätsel Nummer 62

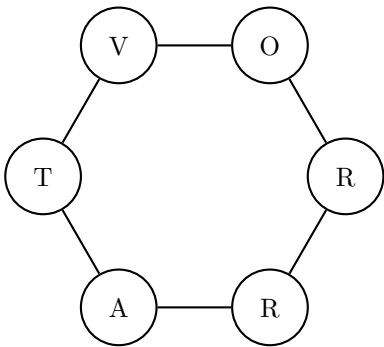

Rätsel Nummer 63

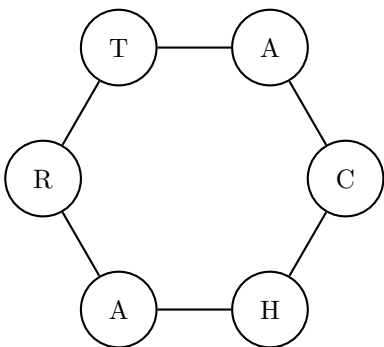

Rätsel Nummer 64

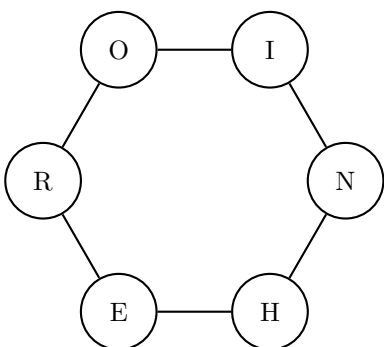

Rätsel Nummer 65

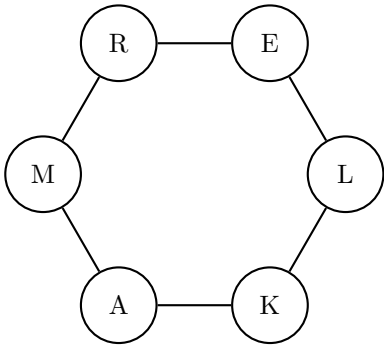

Rätsel Nummer 66

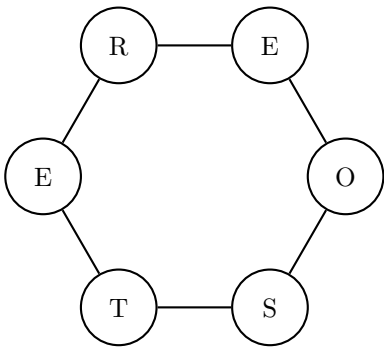

Rätsel Nummer 67

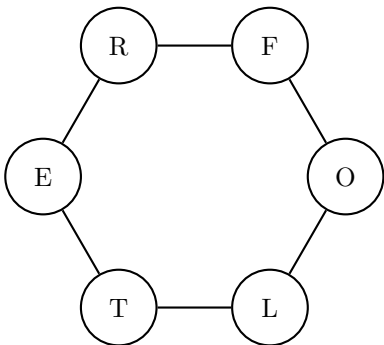

Rätsel Nummer 68

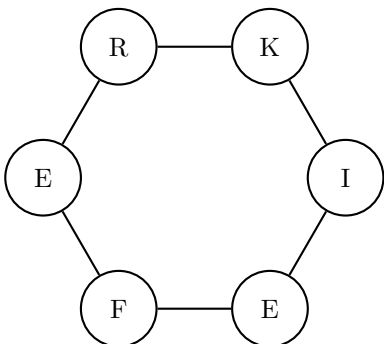

Rätsel Nummer 69

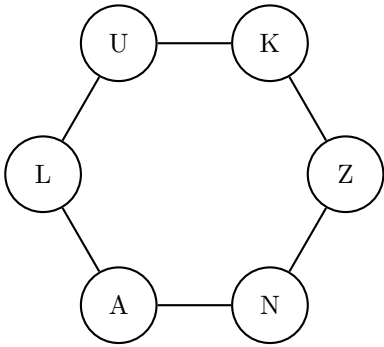

Rätsel Nummer 70

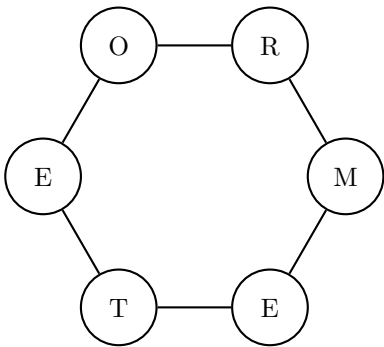

Rätsel Nummer 71

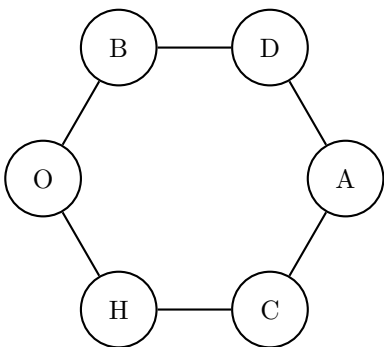

Rätsel Nummer 72

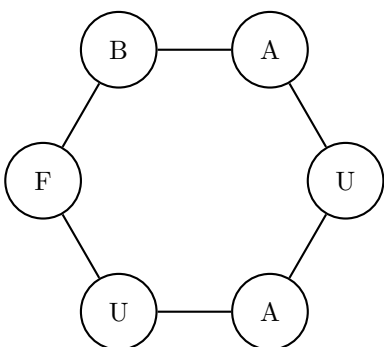

Rätsel Nummer 73

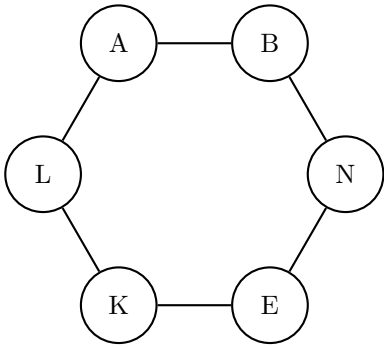

Rätsel Nummer 74

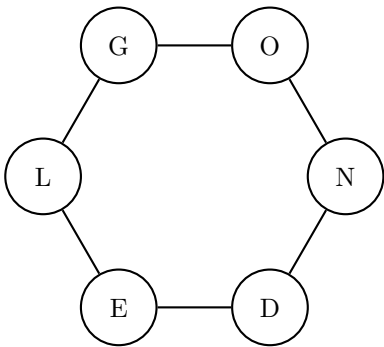

Rätsel Nummer 75

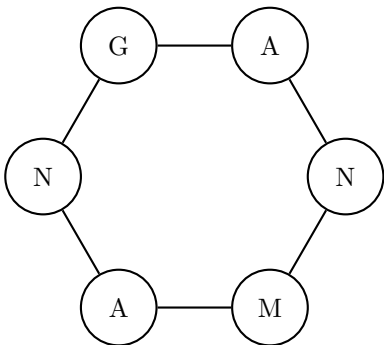

Rätsel Nummer 76

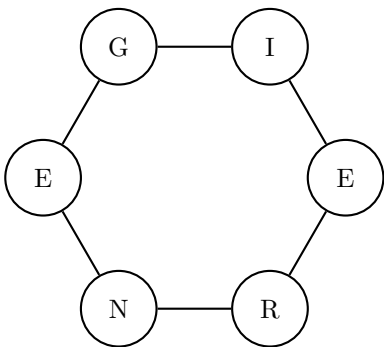

Rätsel Nummer 77

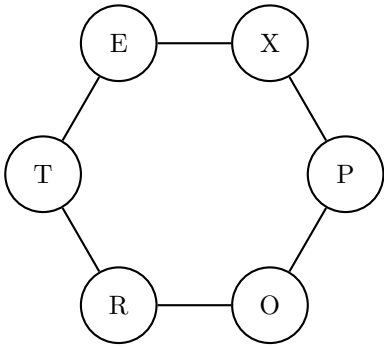

Rätsel Nummer 78

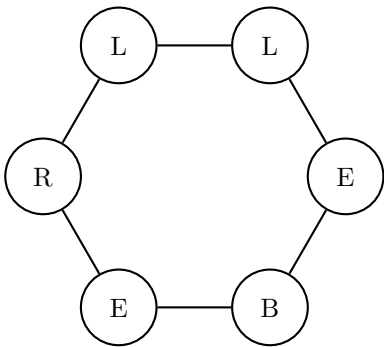

Rätsel Nummer 79

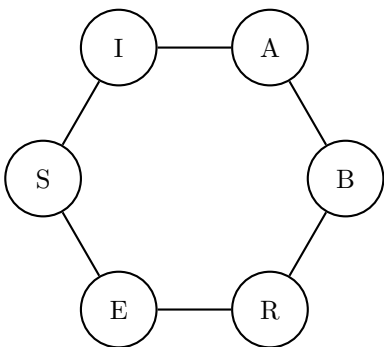

Rätsel Nummer 80

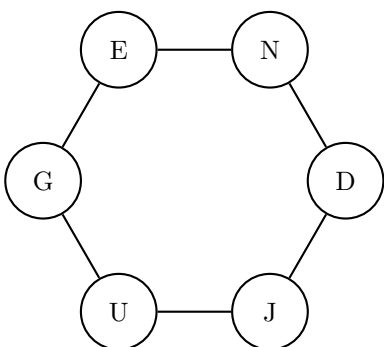

Rätsel Nummer 81

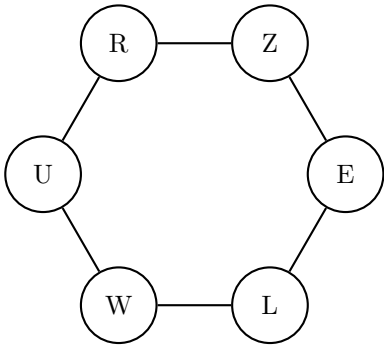

Rätsel Nummer 82

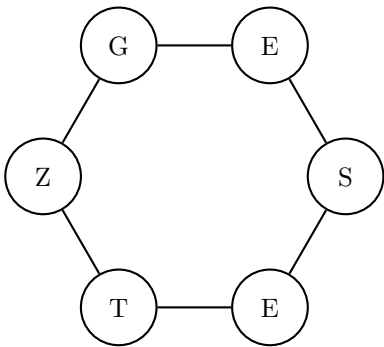

Rätsel Nummer 83

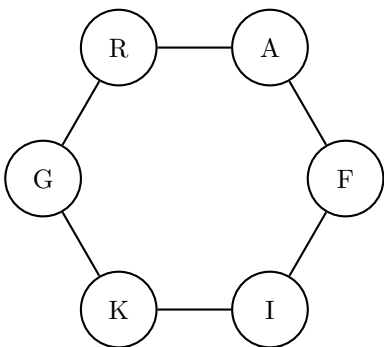

Rätsel Nummer 84

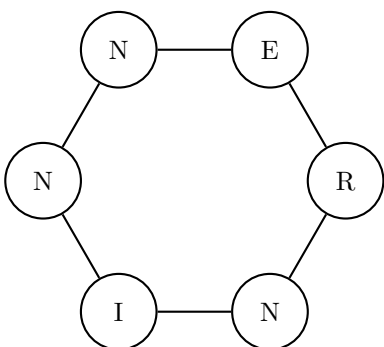

Rätsel Nummer 85

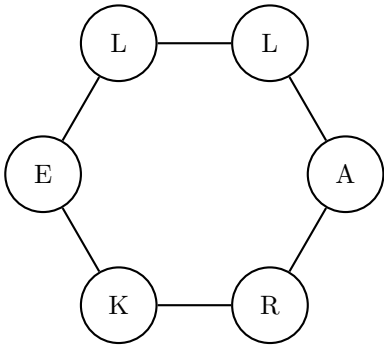

Rätsel Nummer 86

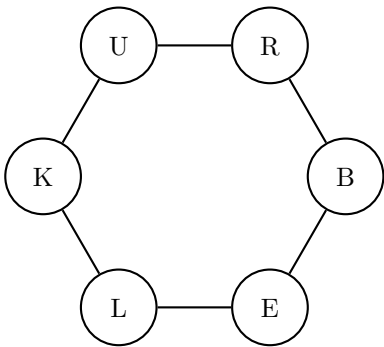

Rätsel Nummer 87

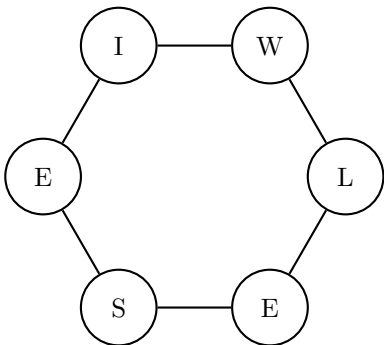

Rätsel Nummer 88

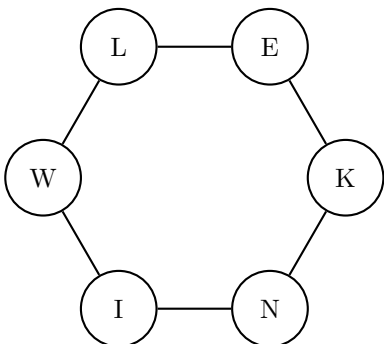

Rätsel Nummer 89

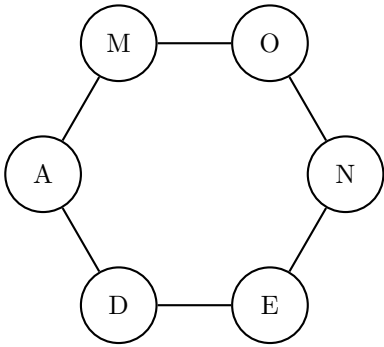

Rätsel Nummer 90

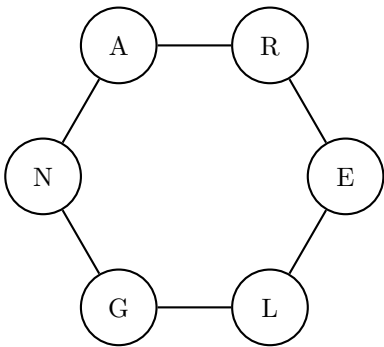

Rätsel Nummer 91

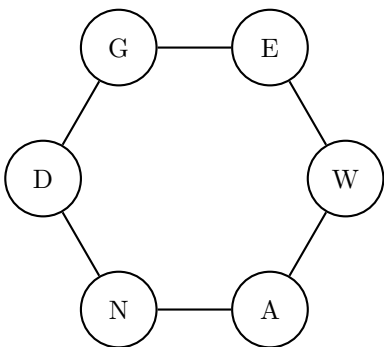

Rätsel Nummer 92

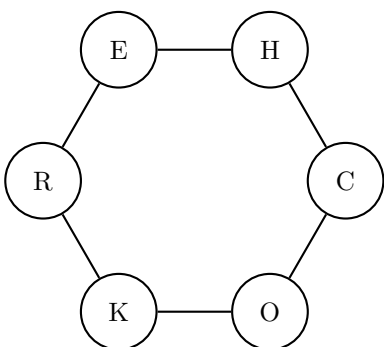

Rätsel Nummer 93

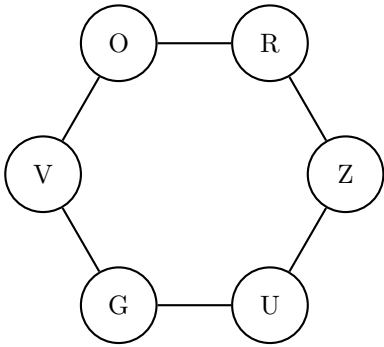

Rätsel Nummer 94

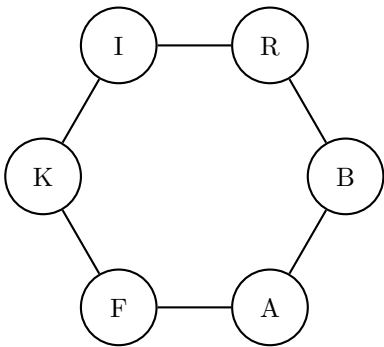

Rätsel Nummer 95

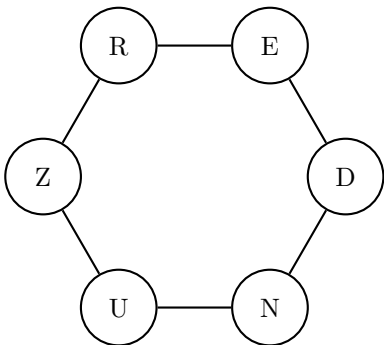

Rätsel Nummer 96

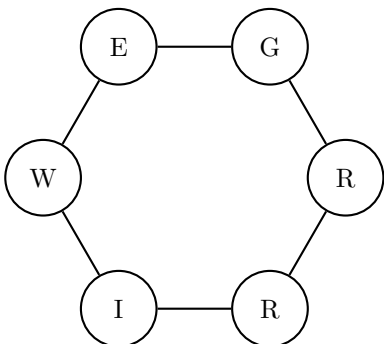

Rätsel Nummer 97

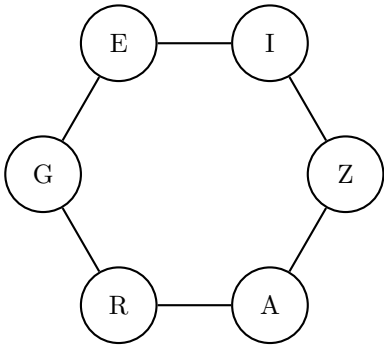

Rätsel Nummer 98

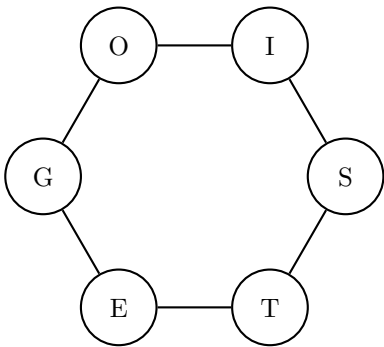

Rätsel Nummer 99

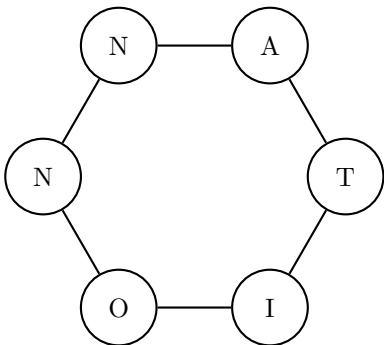

Rätsel Nummer 100

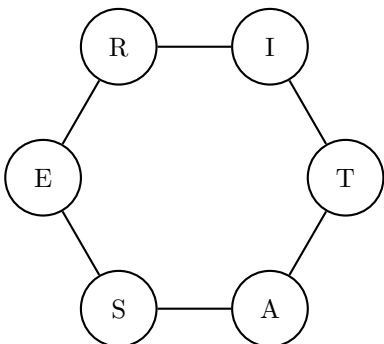

Lösung

1.SOMMER	34.FRAGER	67.FOLTER
2.RAHMEN	35.TERROR	68.KIEFER
3.BENGEL	36.TRAPEZ	69.KULANZ
4.KARIES	37.KURIER	70.METEOR
5.PUZZLE	38.TATORT	71.OBDACH
6.REGLER	39.HAMMEL	72.AUFBAU
7.SICHEL	40.KNICKS	73.BALKEN
8.GEMACH	41.RADIAN	74.GONDEL
9.STUNDE	42.KRESSE	75.MANGAN
10.WIMPER	43.SCHEMA	76.REIGEN
11.ESELEI	44.VALUTA	77.EXPORT
12.ABITUR	45.GALOPP	78.REBELL
13.CHEMIE	46.PENSUM	79.BAISER
14.NICKEL	47.GARTEN	80.JUGEND
15.TRIBUN	48.GITTER	81.WURZEL
16.ANLAUF	49.PROFIL	82.GESETZ
17.AUSRUF	50.TURNER	83.GRAFIK
18.PHYSIK	51.METALL	84.INNERN
19.AKTION	52.TRESOR	85.KRALLE
20.KELLER	53.VASALL	86.KURBEL
21.AKTEUR	54.BIETER	87.WIESEL
22.AKZEPT	55.SAISON	88.WINKEL
23.HEBUNG	56.HEKTAR	89.NOMADE
24.PIRSCH	57.KNOLLE	90.ANGLER
25.NICHTE	58.DOTTER	91.GEWAND
26.JANUAR	59.GEBIET	92.KOCHER
27.SCHREI	60.GEGEND	93.VORZUG
28.FRESKE	61.TRAUER	94.FABRIK
29.KOSAKE	62.VORRAT	95.ZUNDER
30.LAYOUT	63.CHARTA	96.GEWIRR
31.MIKADO	64.HEROIN	97.GRAZIE
32.PODIEN	65.MAKLER	98.EGOIST
33.SPAGAT	66.STEREO	99.NATION
		100.SATIRE