

100 Kreiswörter mit 6 Buchstaben Teil 4

Sascha Frank
www.kreiswort.de

12. Dezember 2012

Die gesuchten Wörter sind in einem Kreis aus Buchstaben versteckt. Das Wort kann vorwärts und rückwärts im Kreis stehen. Insgesamt gibt es 100 Rätsel zu lösen, am Ende gibt es eine kurze Lösung.

Mit freundlicher Unterstützung von:
Autobett Kinderzimmer Sport V8 in rot

Paraffinbad für Ihre Hände

Zinseszins Rechner

Gesucht

ABGABE	FRISUR	MISERE
ABLAUT	FROSCH	MOMENT
ABREDE	FURCHT	PANZER
ABWEHR	GANOVE	PARADE
ABWURF	GEHWEG	PHARAO
AKZENT	GEMAHL	RAUSCH
ANKAUF	GERUCH	REEDER
ANREIZ	GESUCH	REGUNG
ARZNEI	GLOCKE	REKTOR
BASLER	GROTTE	REVIER
BAUXIT	HAUSSE	RIEGEL
BEFEHL	HIMMEL	ROSINE
BELANG	HORROR	RUMMEL
BESTIE	INGWER	SAPHIR
BEWEIS	INHALT	SCHALK
BUDGET	INLAND	SCHLAF
BUKETT	KAISER	SIEGER
COUPON	KAMERA	SKLAVE
COUSIN	KERBEL	SLOGAN
DASEIN	KLIENT	SOLDAT
DECKEL	KLINIK	SONATE
DETAIL	KOBALT	STANGE
DIALOG	KOLLER	STREIK
DONNER	KONSUM	STULLE
DRUIDE	KUCHEN	TAILLE
EINBAU	LASTER	TRANCE
EINRAD	LEGUAN	TRIKOT
EINSEN	MAGIER	VERRAT
EINZUG	MANDAT	VERZUG
ERFOLG	MARINE	VORBAU
FERKEL	MASCHE	WIDDER
FLUCHT	MEDIUM	WILLEN
FORMAT	MIETER	ZIMMER
		ZYANID

Rätsel Nummer 1

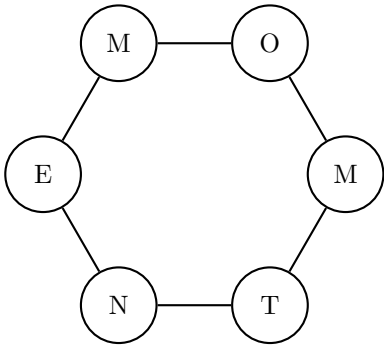

Rätsel Nummer 2

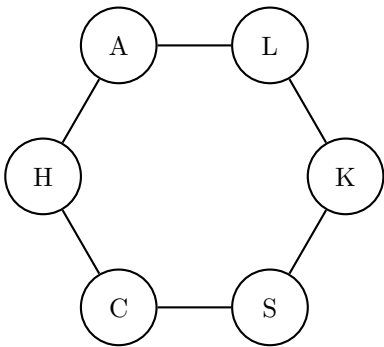

Rätsel Nummer 3

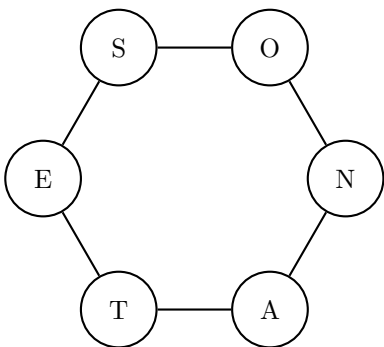

Rätsel Nummer 4

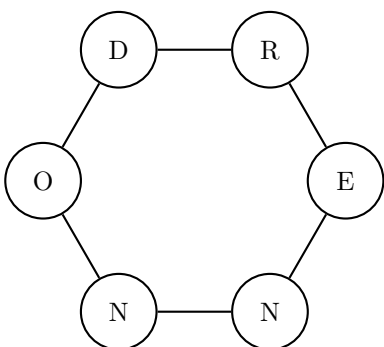

Rätsel Nummer 5

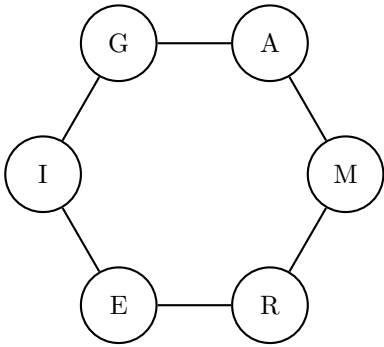

Rätsel Nummer 6

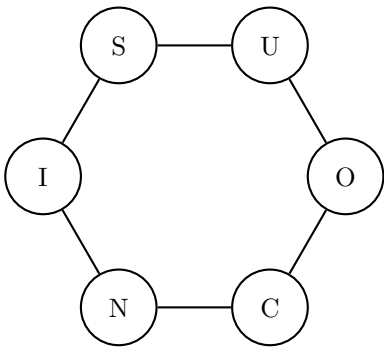

Rätsel Nummer 7

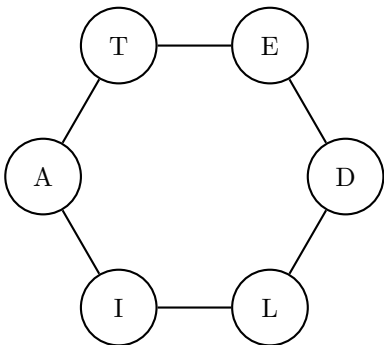

Rätsel Nummer 8

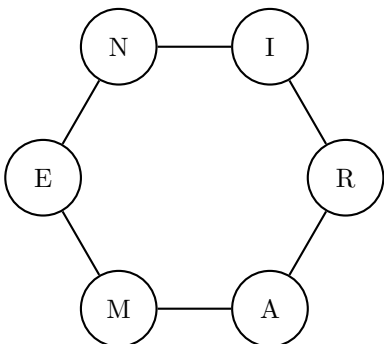

Rätsel Nummer 9

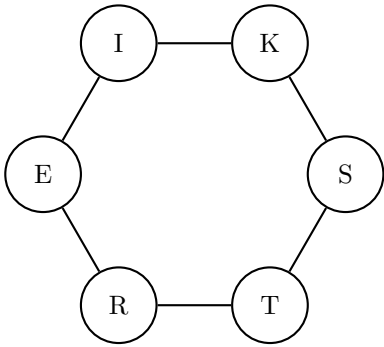

Rätsel Nummer 10

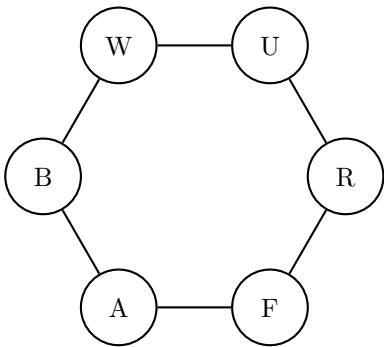

Rätsel Nummer 11

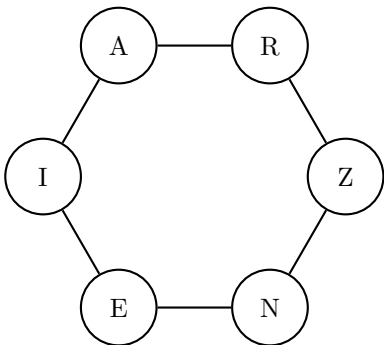

Rätsel Nummer 12

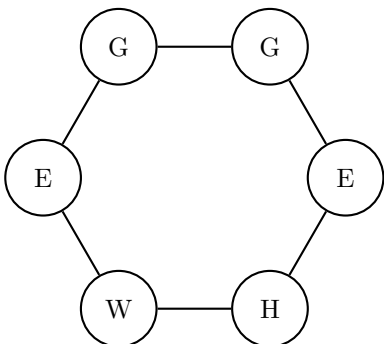

Rätsel Nummer 13

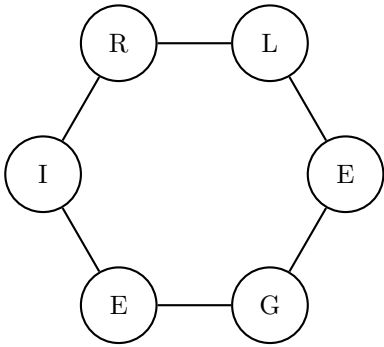

Rätsel Nummer 14

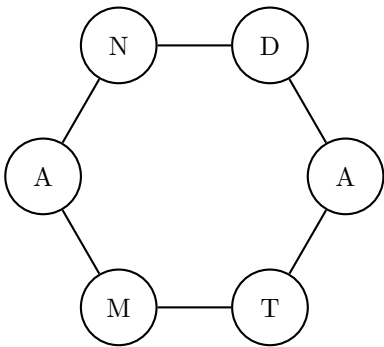

Rätsel Nummer 15

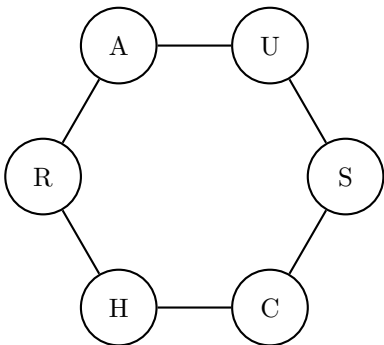

Rätsel Nummer 16

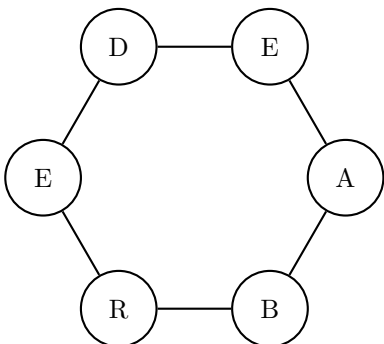

Rätsel Nummer 17

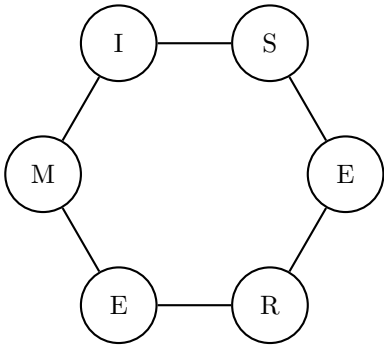

Rätsel Nummer 18

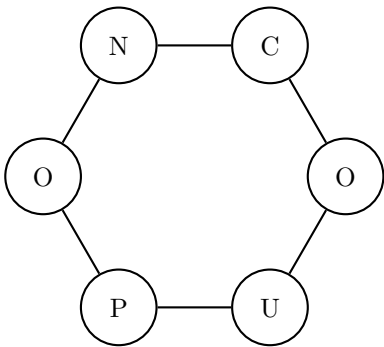

Rätsel Nummer 19

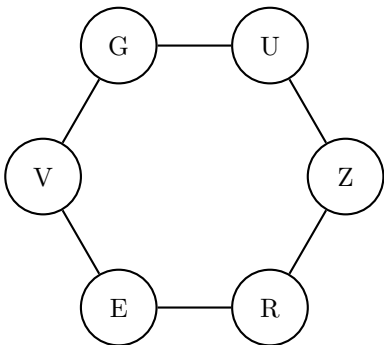

Rätsel Nummer 20

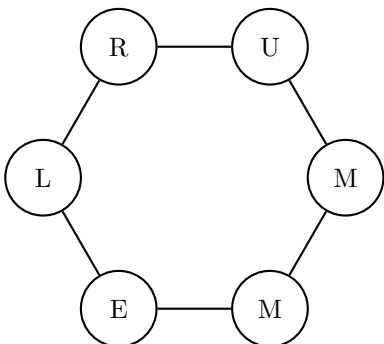

Rätsel Nummer 21

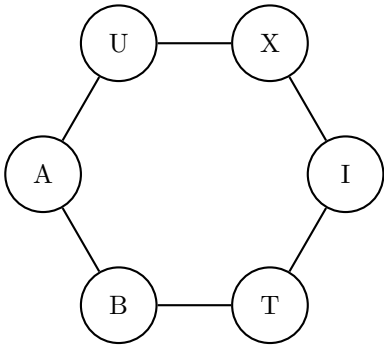

Rätsel Nummer 22

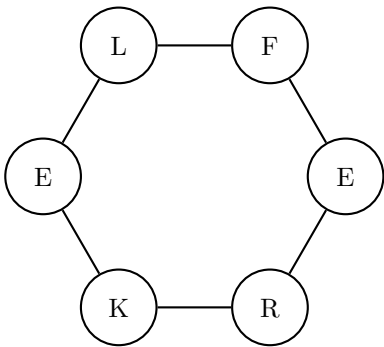

Rätsel Nummer 23

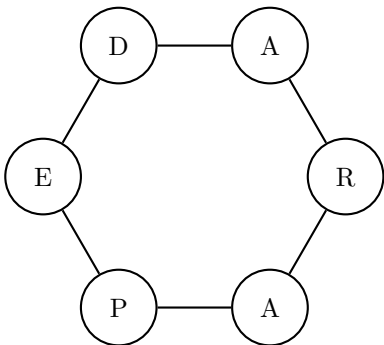

Rätsel Nummer 24

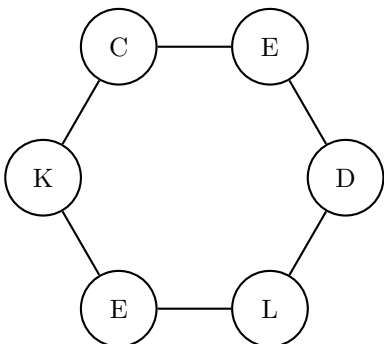

Rätsel Nummer 25

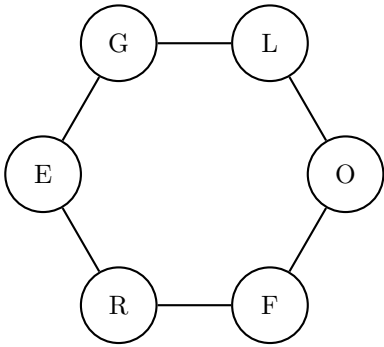

Rätsel Nummer 26

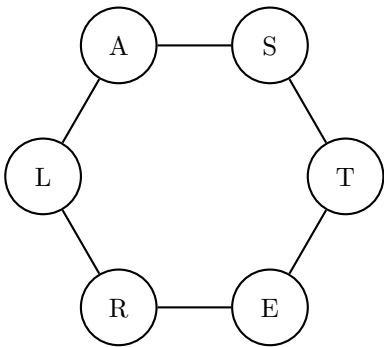

Rätsel Nummer 27

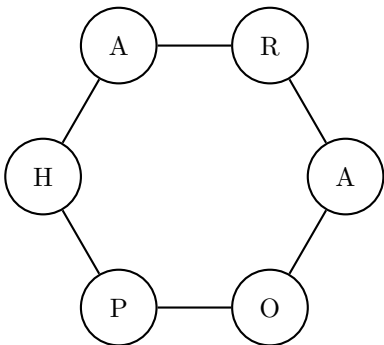

Rätsel Nummer 28

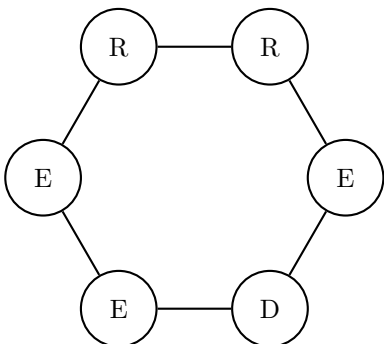

Rätsel Nummer 29

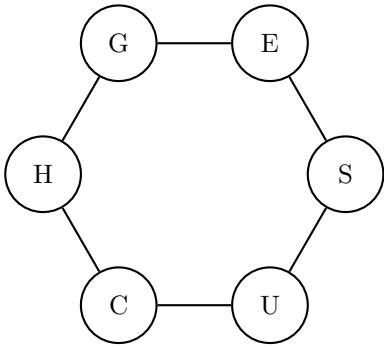

Rätsel Nummer 30

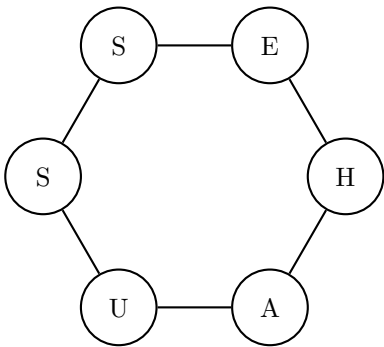

Rätsel Nummer 31

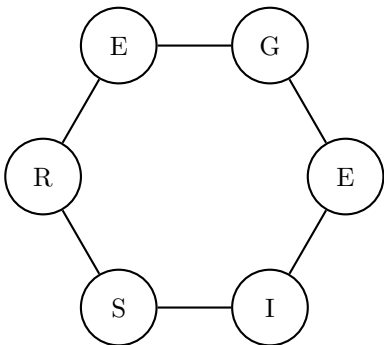

Rätsel Nummer 32

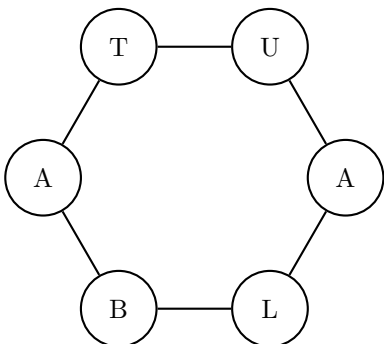

Rätsel Nummer 33

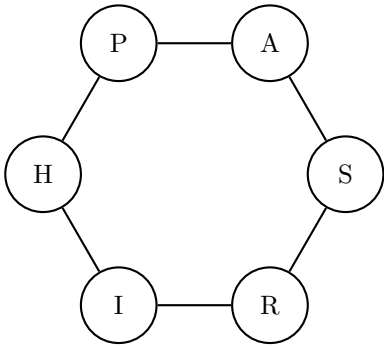

Rätsel Nummer 34

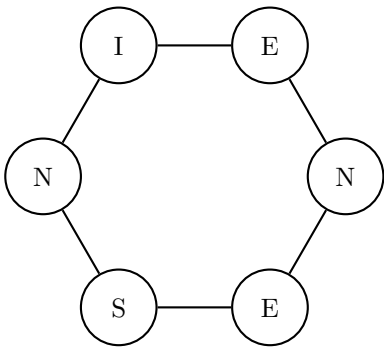

Rätsel Nummer 35

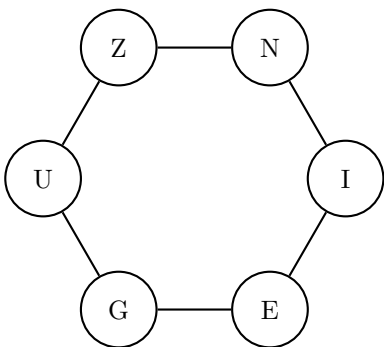

Rätsel Nummer 36

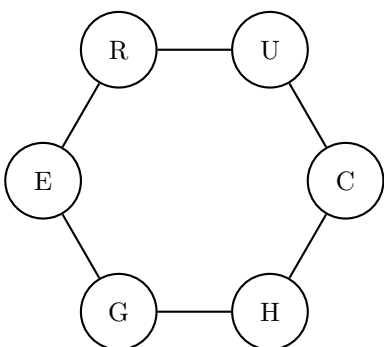

Rätsel Nummer 37

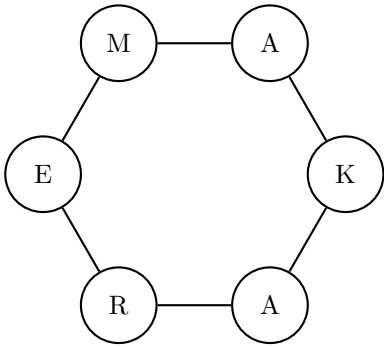

Rätsel Nummer 38

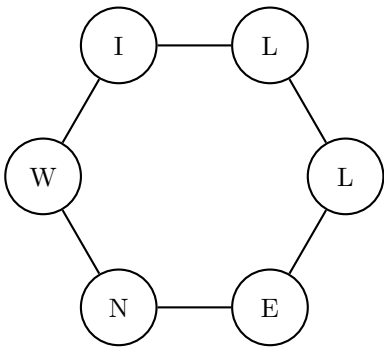

Rätsel Nummer 39

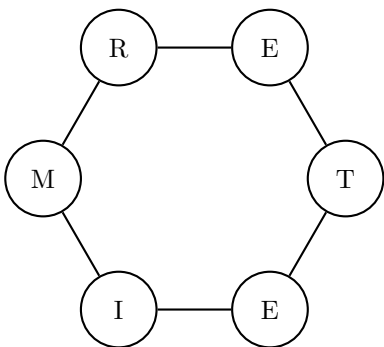

Rätsel Nummer 40

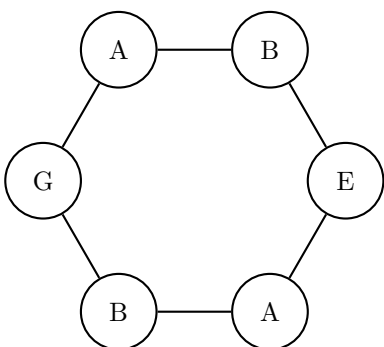

Rätsel Nummer 41

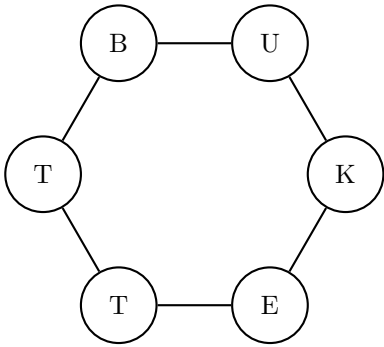

Rätsel Nummer 42

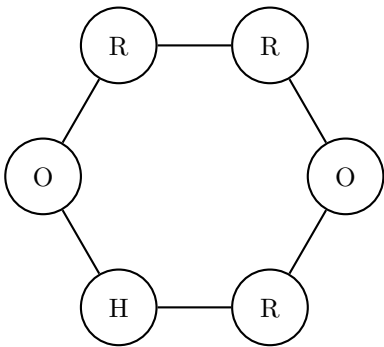

Rätsel Nummer 43

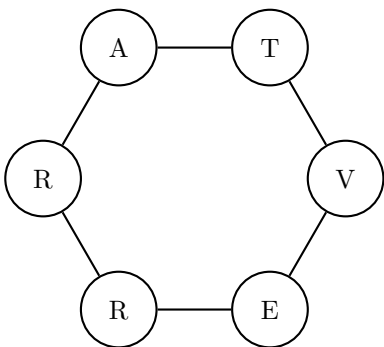

Rätsel Nummer 44

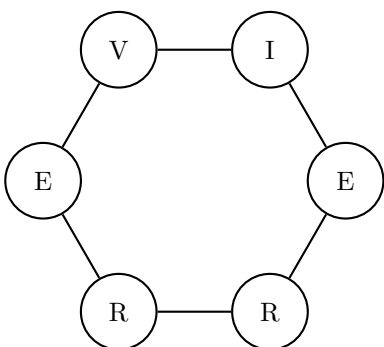

Rätsel Nummer 45

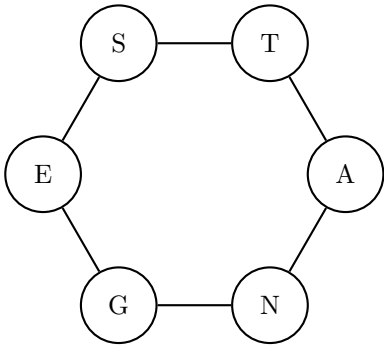

Rätsel Nummer 46

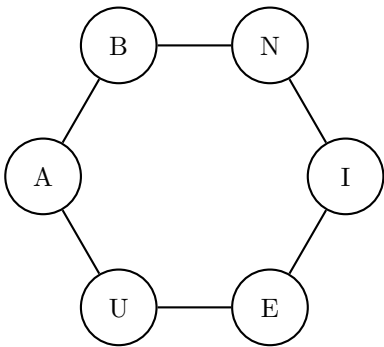

Rätsel Nummer 47

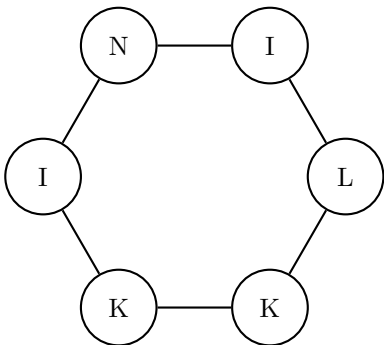

Rätsel Nummer 48

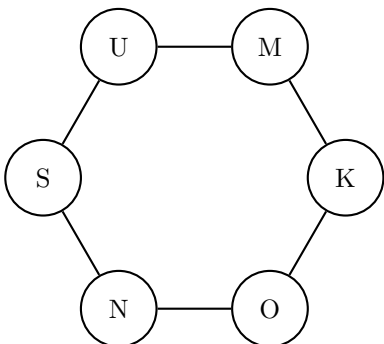

Rätsel Nummer 49

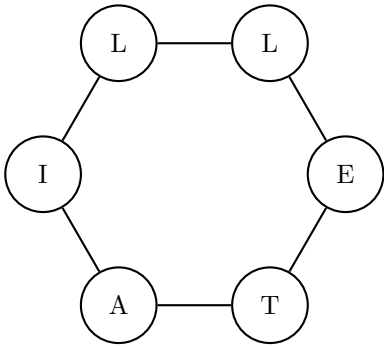

Rätsel Nummer 50

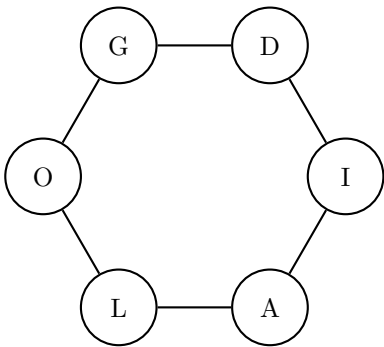

Rätsel Nummer 51

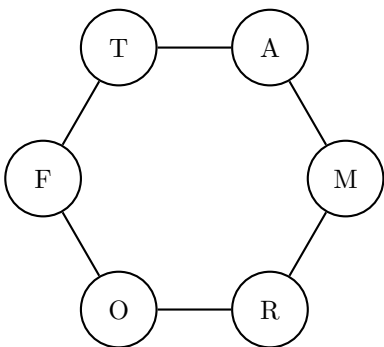

Rätsel Nummer 52

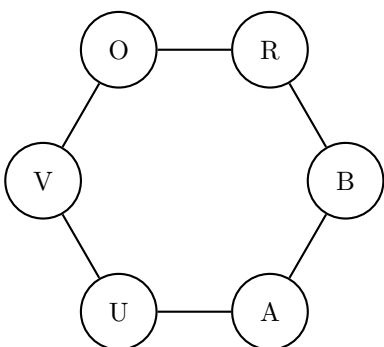

Rätsel Nummer 53

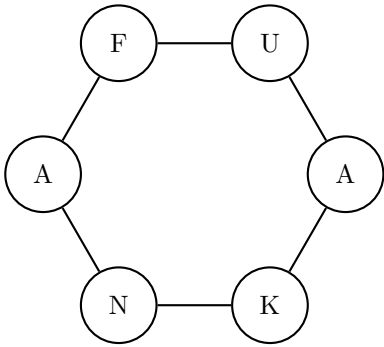

Rätsel Nummer 54

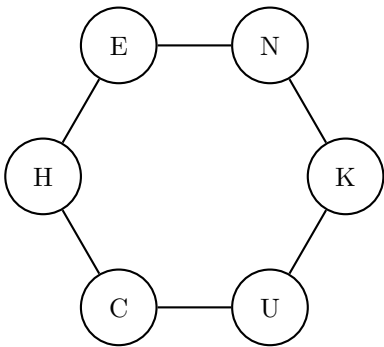

Rätsel Nummer 55

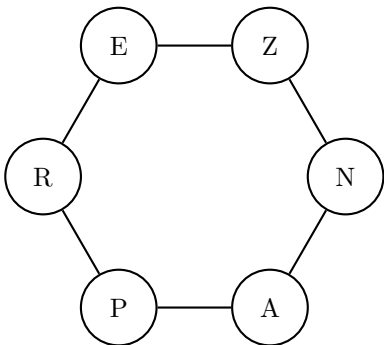

Rätsel Nummer 56

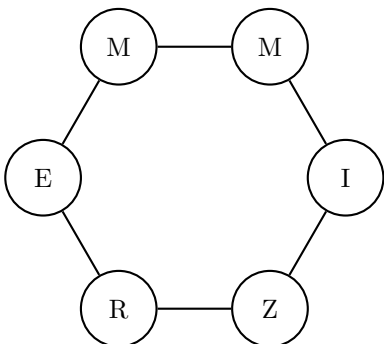

Rätsel Nummer 57

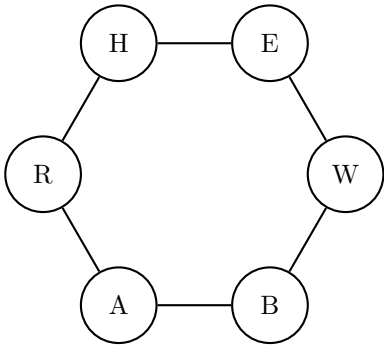

Rätsel Nummer 58

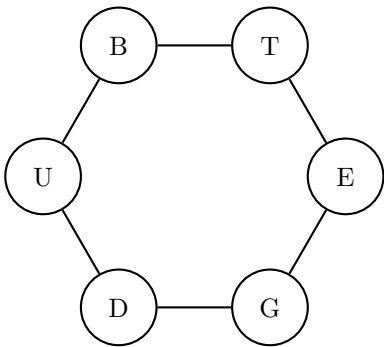

Rätsel Nummer 59

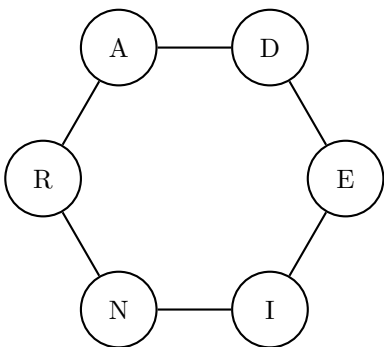

Rätsel Nummer 60

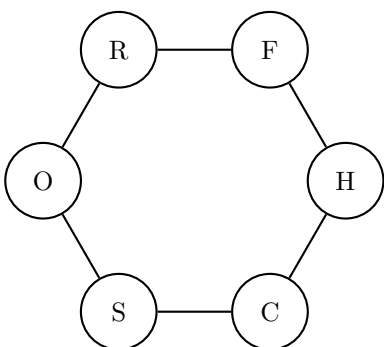

Rätsel Nummer 61

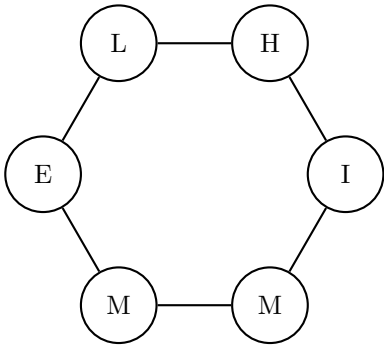

Rätsel Nummer 62

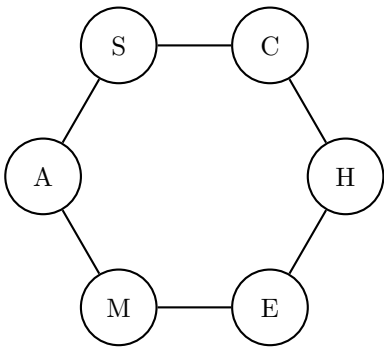

Rätsel Nummer 63

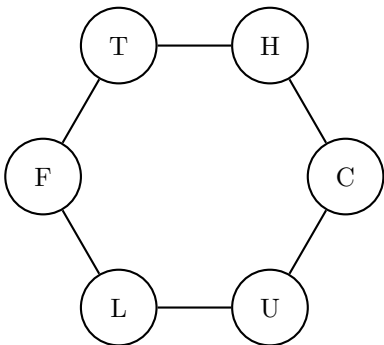

Rätsel Nummer 64

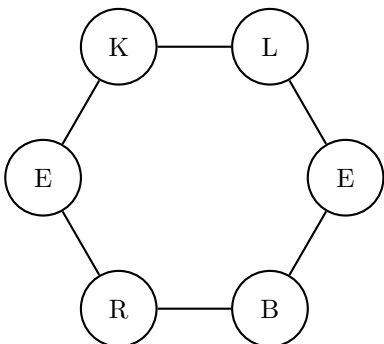

Rätsel Nummer 65

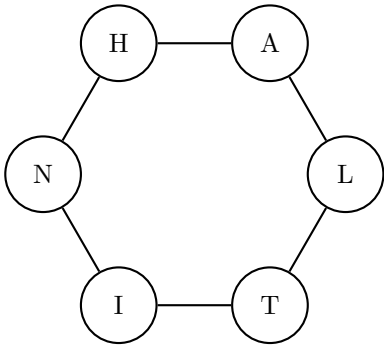

Rätsel Nummer 66

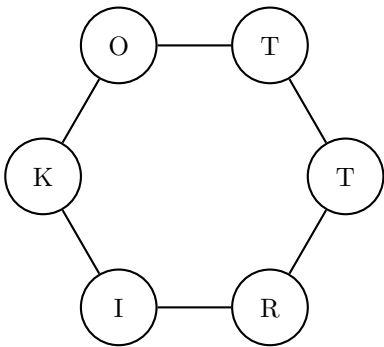

Rätsel Nummer 67

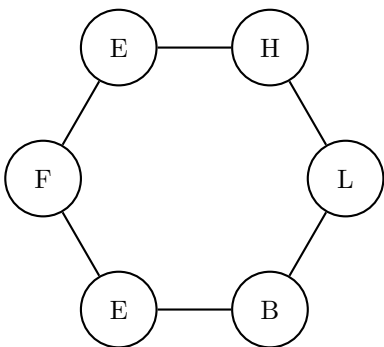

Rätsel Nummer 68

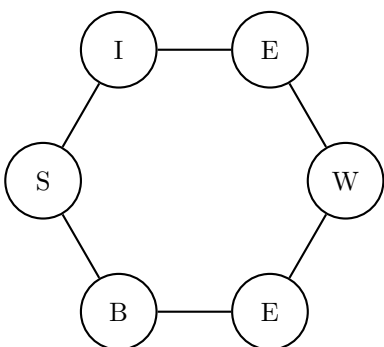

Rätsel Nummer 69

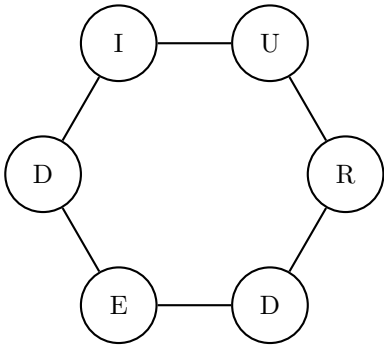

Rätsel Nummer 70

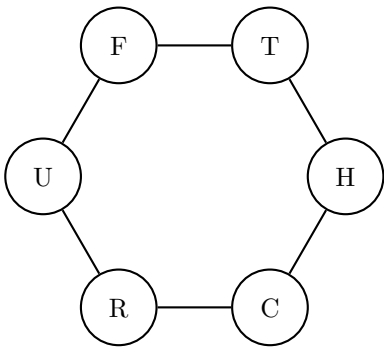

Rätsel Nummer 71

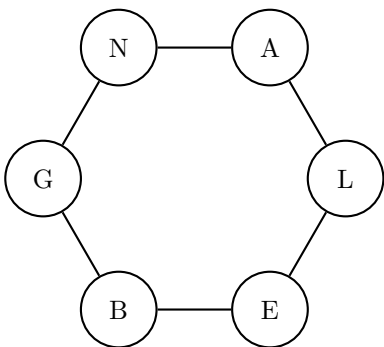

Rätsel Nummer 72

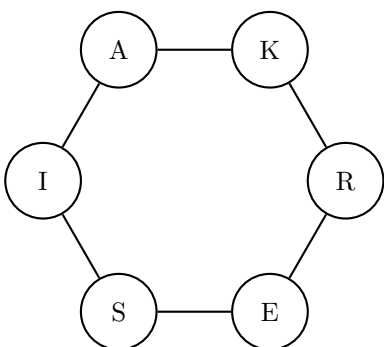

Rätsel Nummer 73

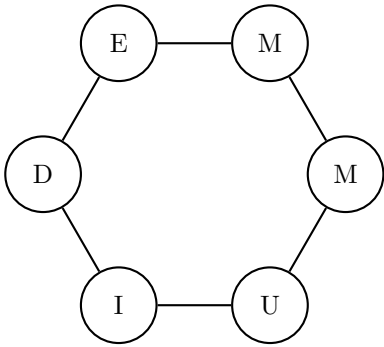

Rätsel Nummer 74

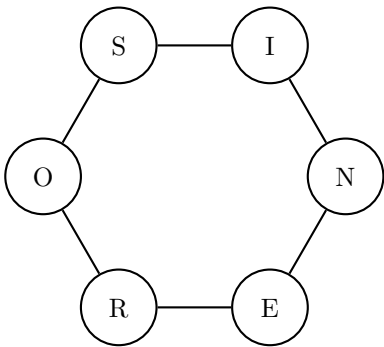

Rätsel Nummer 75

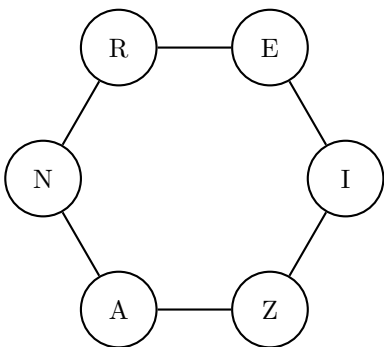

Rätsel Nummer 76

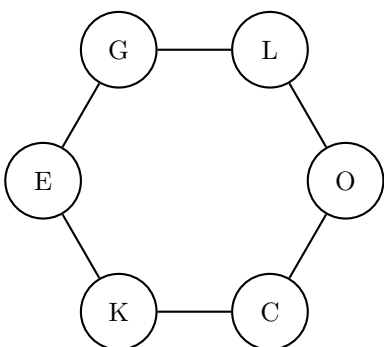

Rätsel Nummer 77

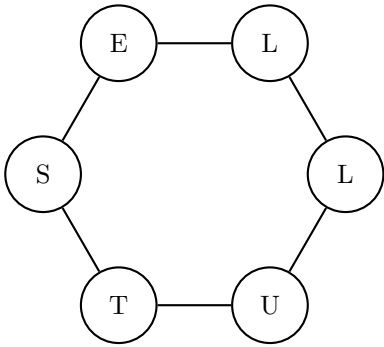

Rätsel Nummer 78

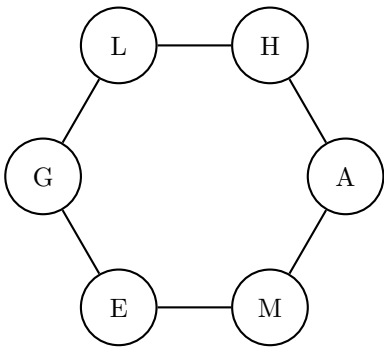

Rätsel Nummer 79

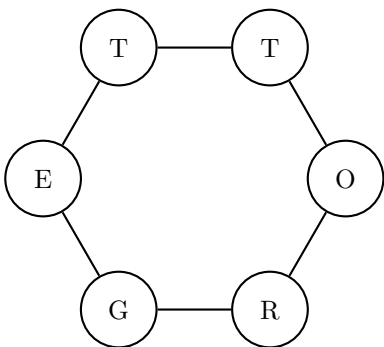

Rätsel Nummer 80

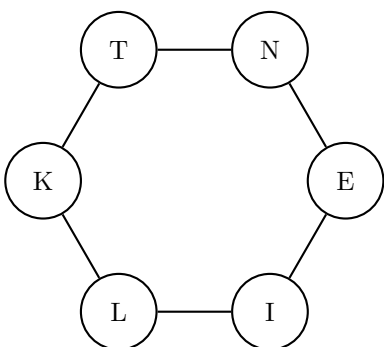

Rätsel Nummer 81

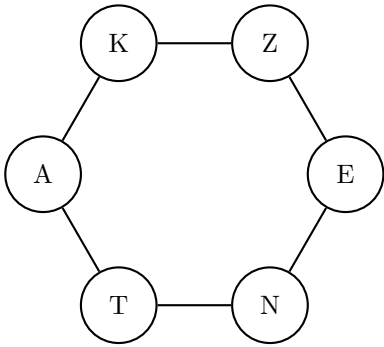

Rätsel Nummer 82

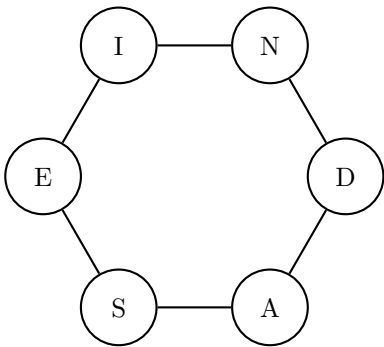

Rätsel Nummer 83

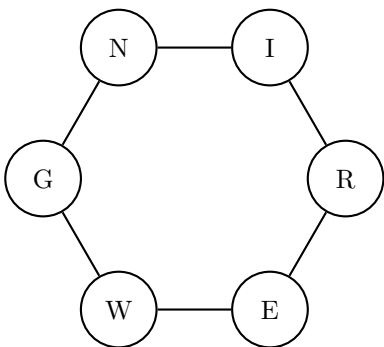

Rätsel Nummer 84

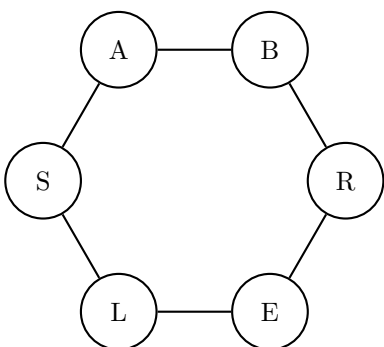

Rätsel Nummer 85

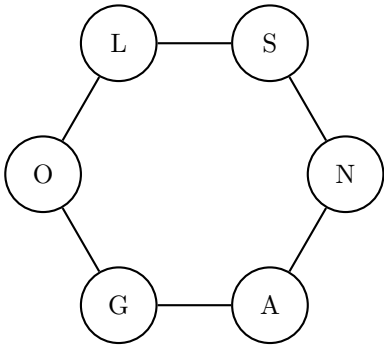

Rätsel Nummer 86

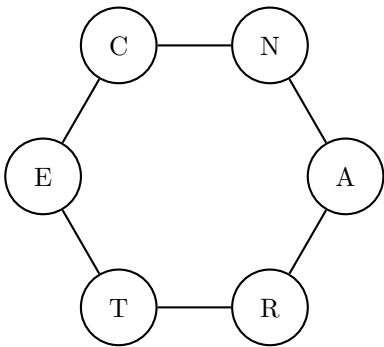

Rätsel Nummer 87

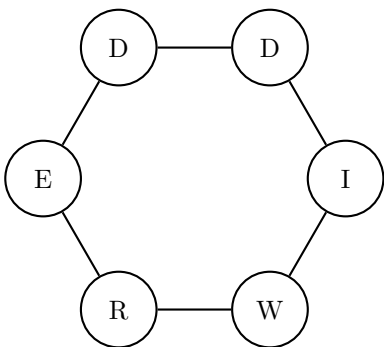

Rätsel Nummer 88

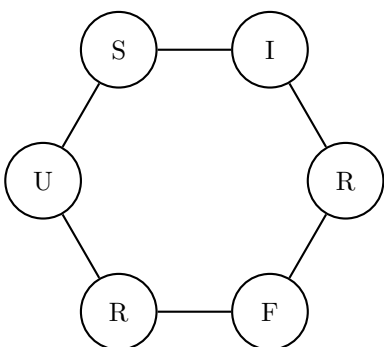

Rätsel Nummer 89

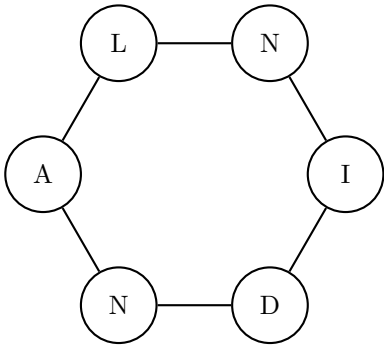

Rätsel Nummer 90

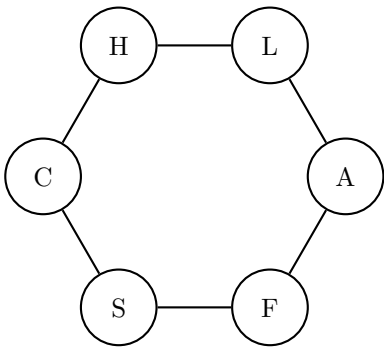

Rätsel Nummer 91

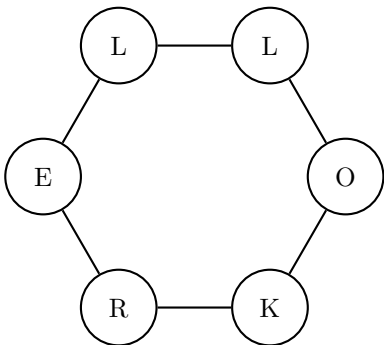

Rätsel Nummer 92

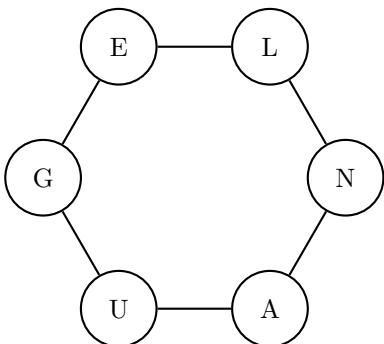

Rätsel Nummer 93

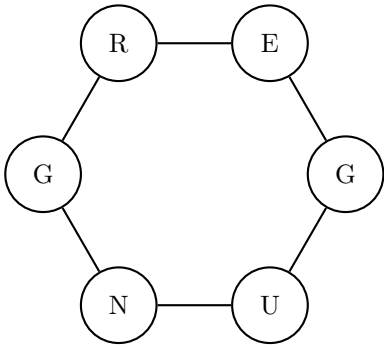

Rätsel Nummer 94

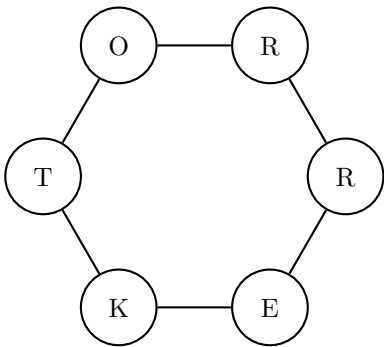

Rätsel Nummer 95

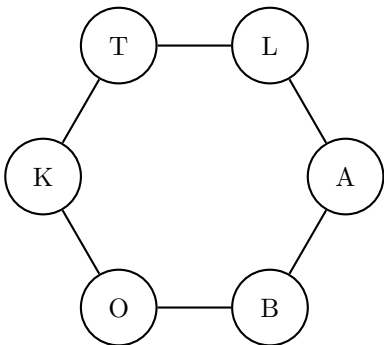

Rätsel Nummer 96

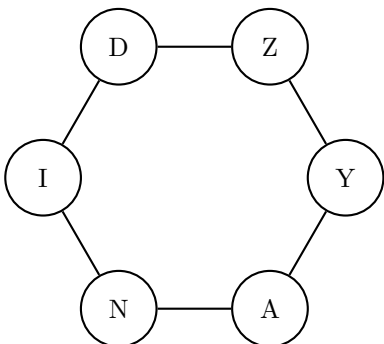

Rätsel Nummer 97

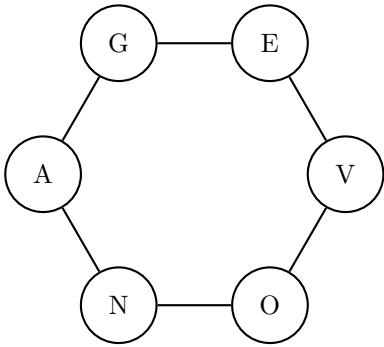

Rätsel Nummer 98

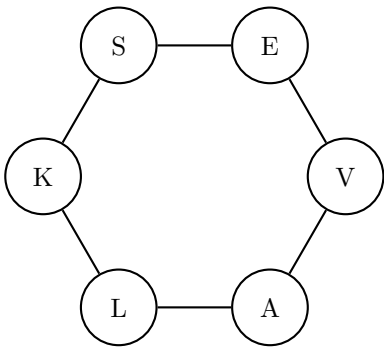

Rätsel Nummer 99

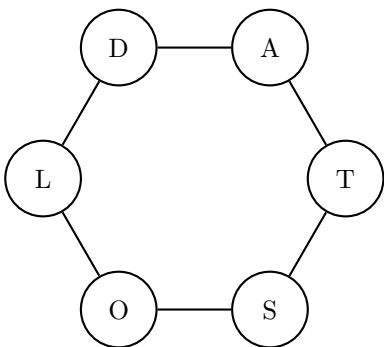

Rätsel Nummer 100

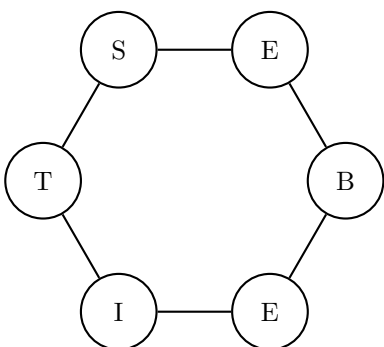

Lösung

- | | | |
|-----------|-----------|------------|
| 1.MOMENT | 34.EINSEN | 67.BEFEHL |
| 2.SCHALK | 35.EINZUG | 68.BEWEIS |
| 3.SONATE | 36.GERUCH | 69.DRUIDE |
| 4.DONNER | 37.KAMERA | 70.FURCHT |
| 5.MAGIER | 38.WILLEN | 71.BELANG |
| 6.COUSIN | 39.MIETER | 72.KAISER |
| 7.DETAIL | 40.ABGABE | 73.MEDIUM |
| 8.MARINE | 41.BUKETT | 74.ROSINE |
| 9.STREIK | 42.HORROR | 75.ANREIZ |
| 10.ABWURF | 43.VERRAT | 76.GLOCKE |
| 11.ARZNEI | 44.REVIER | 77.STULLE |
| 12.GEHWEG | 45.STANGE | 78.GEMAHL |
| 13.RIEGEL | 46.EINBAU | 79.GROTTE |
| 14.MANDAT | 47.KLINIK | 80.KLIENT |
| 15.RAUSCH | 48.KONSUM | 81.AKZENT |
| 16.ABREDE | 49.TAILLE | 82.DASEIN |
| 17.MISERE | 50.DIALOG | 83.INGWER |
| 18.COUPON | 51.FORMAT | 84.BASLER |
| 19.VERZUG | 52.VORBAU | 85.SLOGAN |
| 20.RUMMEL | 53.ANKAUF | 86.TRANCE |
| 21.BAUXIT | 54.KUCHEN | 87.WIDDER |
| 22.FERKEL | 55.PANZER | 88.FRISUR |
| 23.PARADE | 56.ZIMMER | 89.INLAND |
| 24.DECKEL | 57.ABWEHR | 90.SCHLAF |
| 25.ERFOLG | 58.BUDGET | 91.KOLLER |
| 26.LASTER | 59.EINRAD | 92.LEGUAN |
| 27.PHARAO | 60.FROSCH | 93.REGUNG |
| 28.REEDER | 61.HIMMEL | 94.REKTOR |
| 29.GESUCH | 62.MASCHE | 95.KOBALT |
| 30.HAUSSE | 63.FLUCHT | 96.ZYANID |
| 31.SIEGER | 64.KERBEL | 97.GANOVE |
| 32.ABLAUT | 65.INHALT | 98.SKLAVE |
| 33.SAPHIR | 66.TRIKOT | 99.SOLDAT |
| | | 100.BESTIE |