

100 Kreiswörter mit 6 Buchstaben Teil 5

Sascha Frank
www.kreiswort.de

12. Dezember 2012

Die gesuchten Wörter sind in einem Kreis aus Buchstaben versteckt. Das Wort kann vorwärts und rückwärts im Kreis stehen. Insgesamt gibt es 100 Rätsel zu lösen, am Ende gibt es eine kurze Lösung.

Mit freundlicher Unterstützung von:
Mädchen Kinderzimmer PINKY

Nagelstudio Freiburg

Rechner

Gesucht

ABSATZ	FURCHE	NISCHE
AGONIE	FUSION	NYMPHE
AHNUNG	GATTER	ORIENT
ANGINA	GEDECK	PAROLI
ANHALT	GEIFER	PENDEL
ANHIEB	GELENK	PLANER
ARREST	GEWALT	PLENUM
ATHLET	GIPFEL	PULVER
BETRUG	GLATZE	PURPUR
BOLZEN	GRANIT	RACHEN
BORSTE	GRAUPE	REDNER
BRUDER	HANDEL	REPORT
BUNKER	HENKEL	ROGGEN
CASINO	HERBST	SCHALL
CENTER	HUMBUG	SCHIFF
DEKADE	JAGUAR	SCHULD
DELIKT	KABINE	SCHUND
DEVISE	KADETT	SIEGEL
DIADEM	KELVIN	SOLIST
DIKTAT	KENNER	STATUS
DIRNDL	KESSEL	TERMIN
DOMINO	KISSEN	URFORM
DOPPEL	KITTEL	URWALD
DOUBLE	KLIPPE	WAFFEL
DRAGEE	KOPPEL	WEIHER
EILAND	KORKEN	WEIZEN
EINZEL	KRAMPF	WERBER
EMPORE	KUMMER	WISENT
ENTZUG	MARMOR	ZEHNER
EQUIPE	MEDIEN	ZEMENT
EREMIT	MILIEU	ZIERDE
FORMEL	MITTEL	ZUKAUF
FUMMEL	MORAST	ZUNAME
		ZYKLON

Rätsel Nummer 1

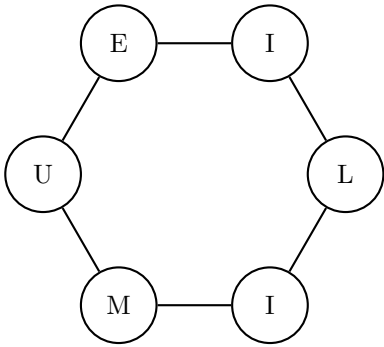

Rätsel Nummer 2

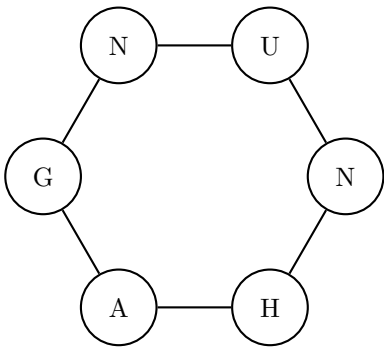

Rätsel Nummer 3

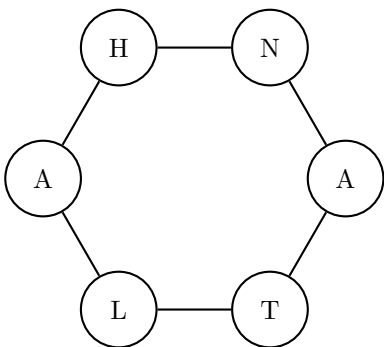

Rätsel Nummer 4

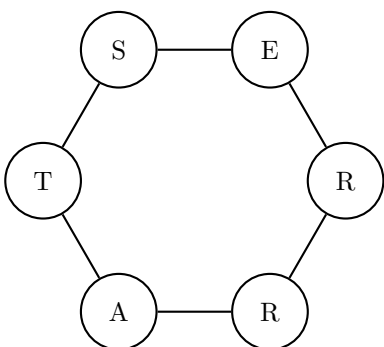

Rätsel Nummer 5

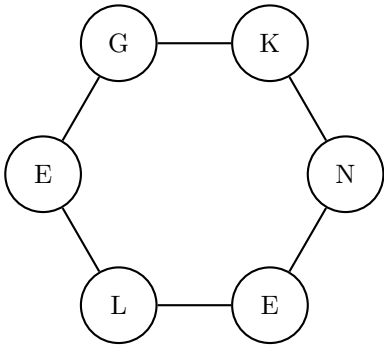

Rätsel Nummer 6

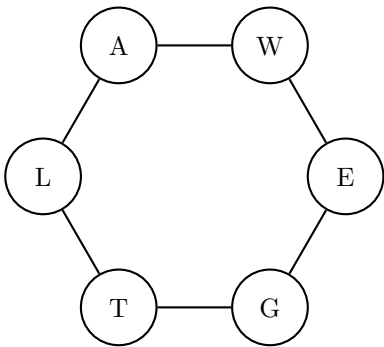

Rätsel Nummer 7

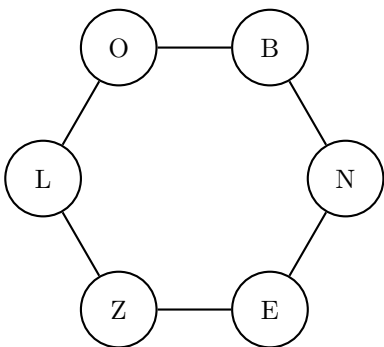

Rätsel Nummer 8

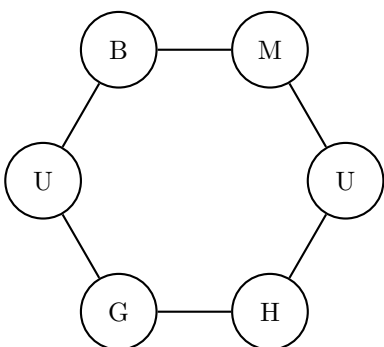

Rätsel Nummer 9

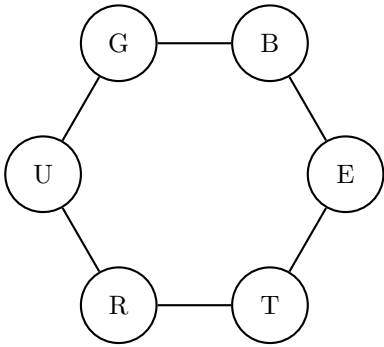

Rätsel Nummer 10

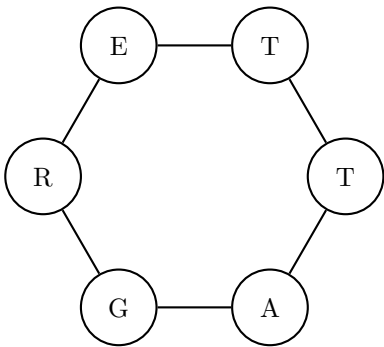

Rätsel Nummer 11

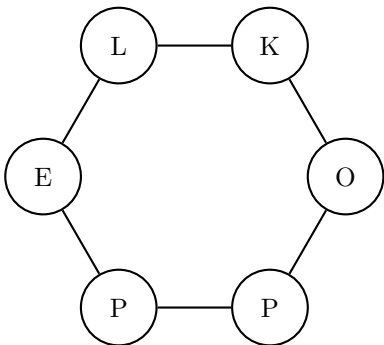

Rätsel Nummer 12

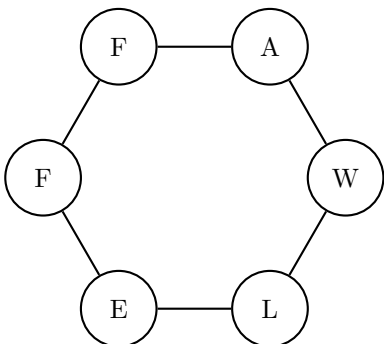

Rätsel Nummer 13

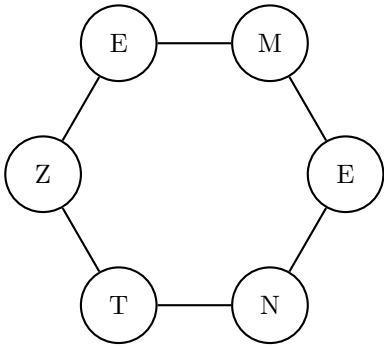

Rätsel Nummer 14

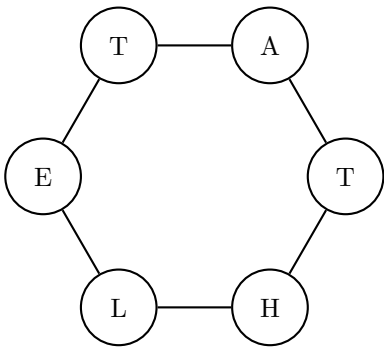

Rätsel Nummer 15

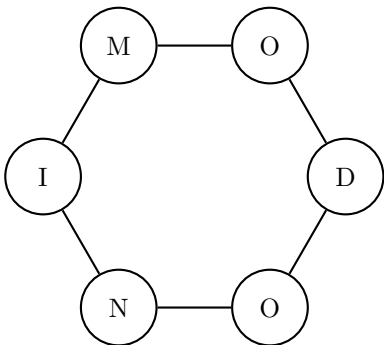

Rätsel Nummer 16

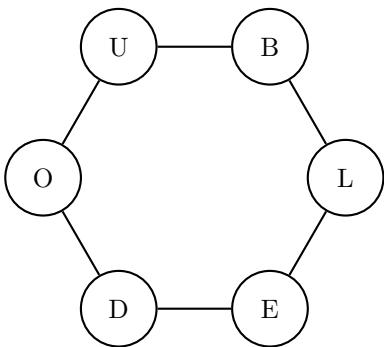

Rätsel Nummer 17

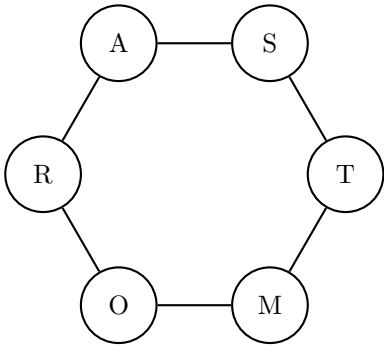

Rätsel Nummer 18

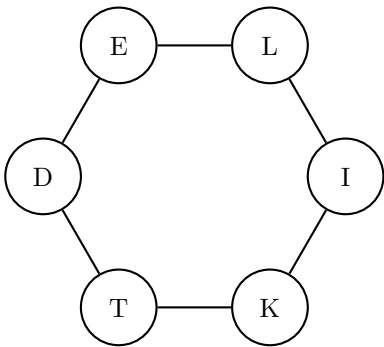

Rätsel Nummer 19

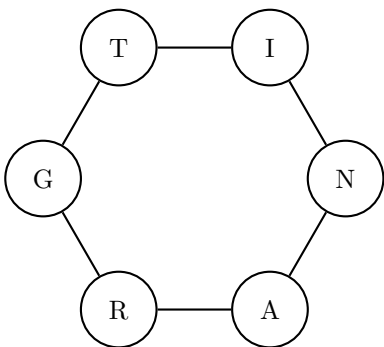

Rätsel Nummer 20

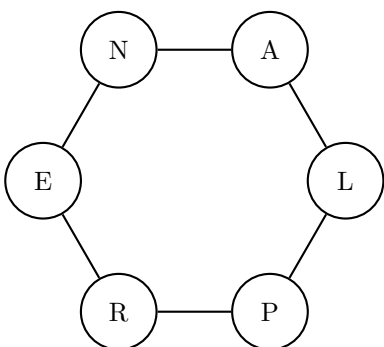

Rätsel Nummer 21

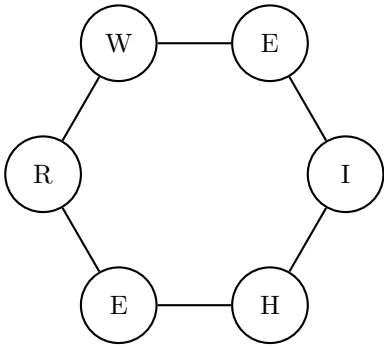

Rätsel Nummer 22

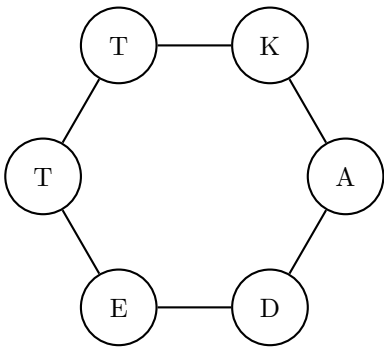

Rätsel Nummer 23

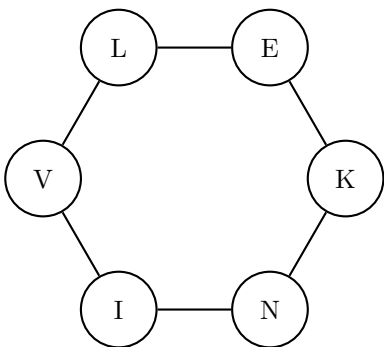

Rätsel Nummer 24

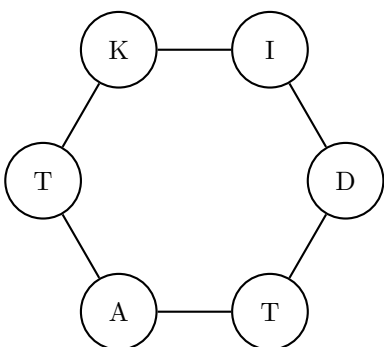

Rätsel Nummer 25

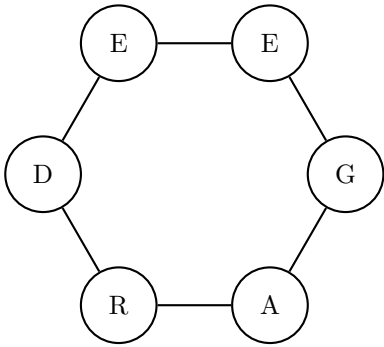

Rätsel Nummer 26

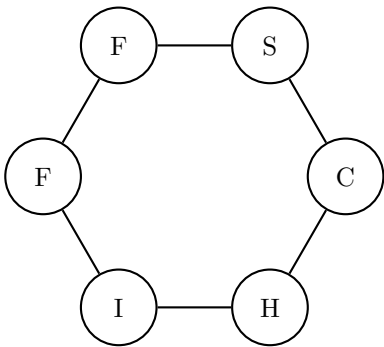

Rätsel Nummer 27

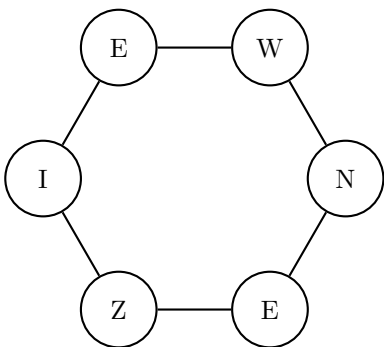

Rätsel Nummer 28

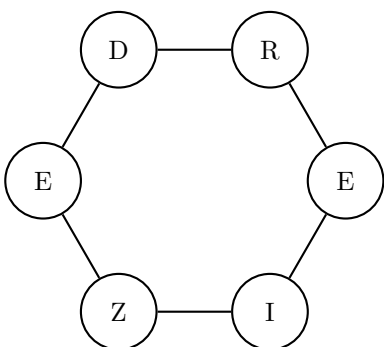

Rätsel Nummer 29

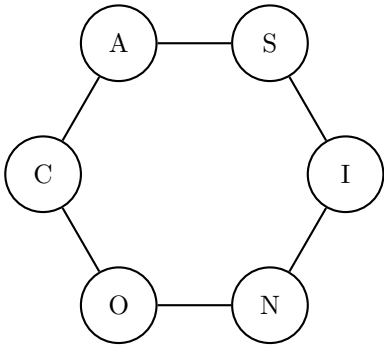

Rätsel Nummer 30

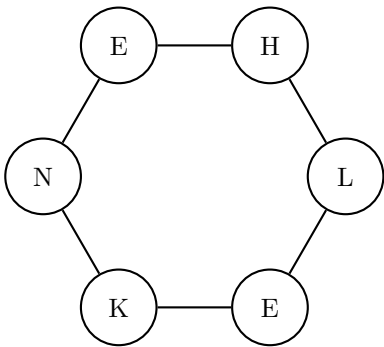

Rätsel Nummer 31

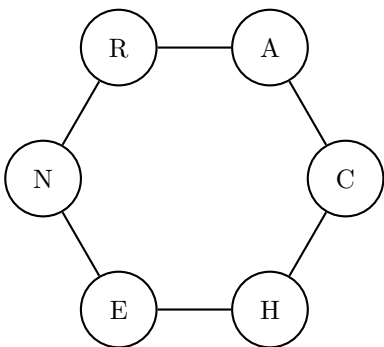

Rätsel Nummer 32

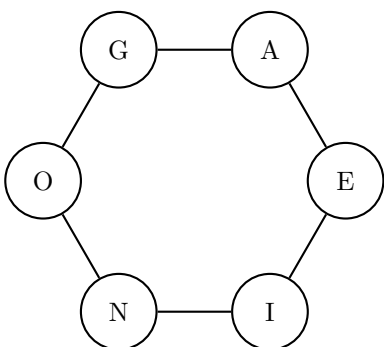

Rätsel Nummer 33

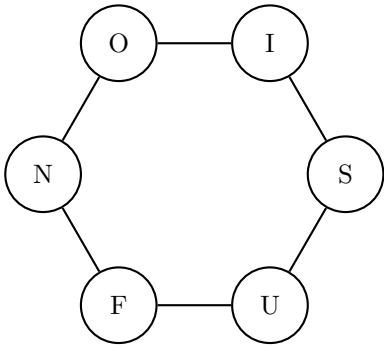

Rätsel Nummer 34

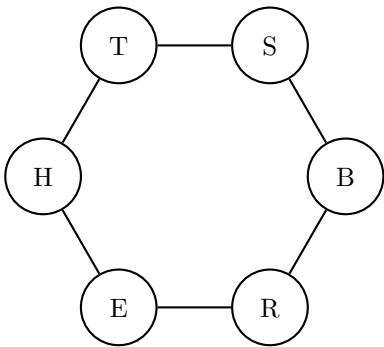

Rätsel Nummer 35

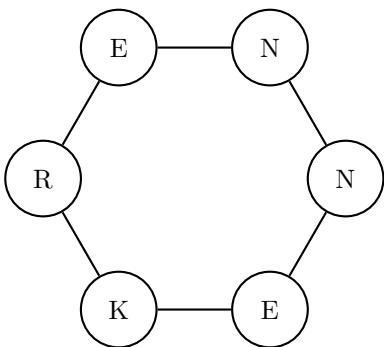

Rätsel Nummer 36

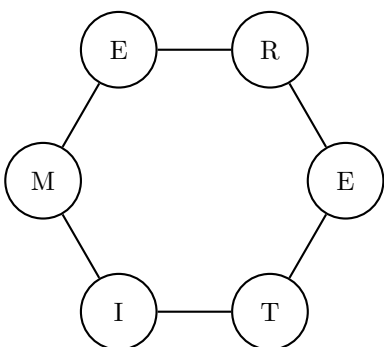

Rätsel Nummer 37

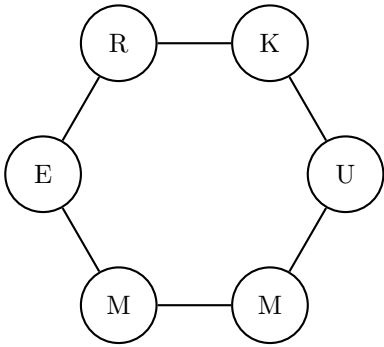

Rätsel Nummer 38

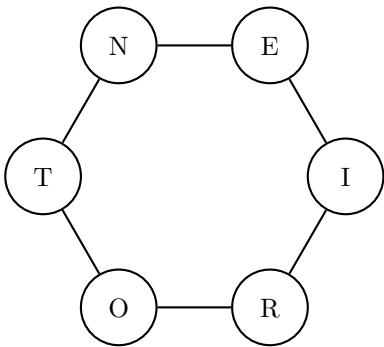

Rätsel Nummer 39

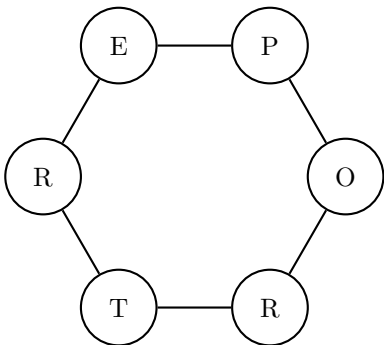

Rätsel Nummer 40

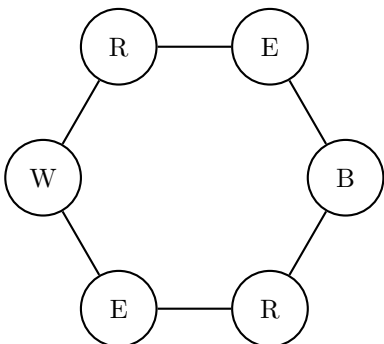

Rätsel Nummer 41

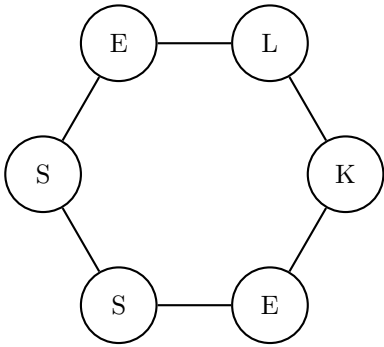

Rätsel Nummer 42

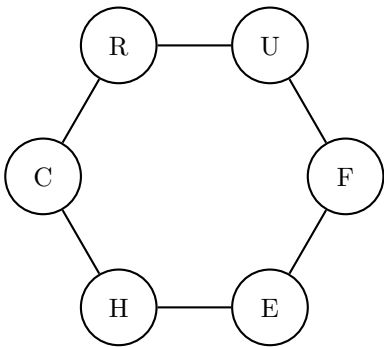

Rätsel Nummer 43

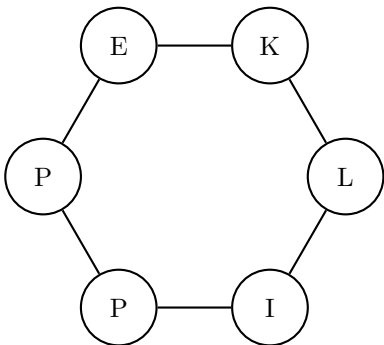

Rätsel Nummer 44

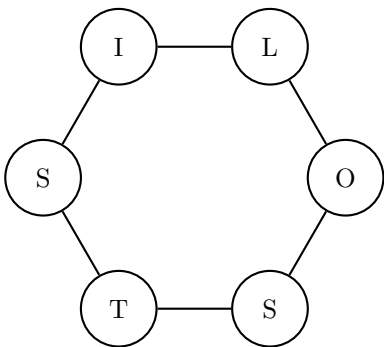

Rätsel Nummer 45

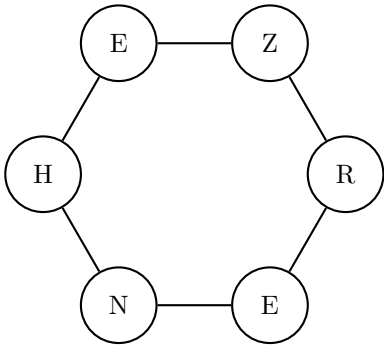

Rätsel Nummer 46

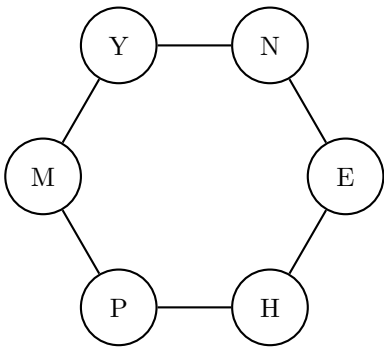

Rätsel Nummer 47

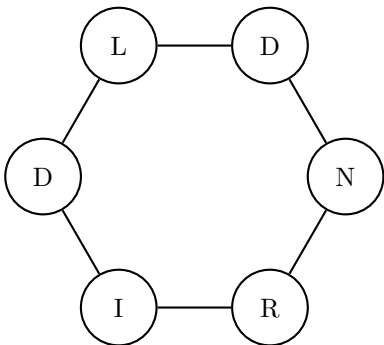

Rätsel Nummer 48

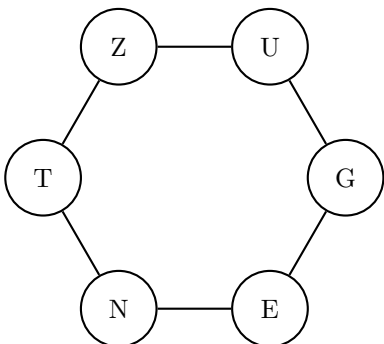

Rätsel Nummer 49

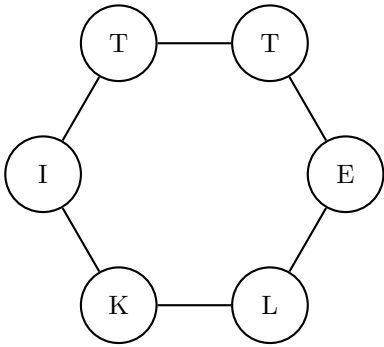

Rätsel Nummer 50

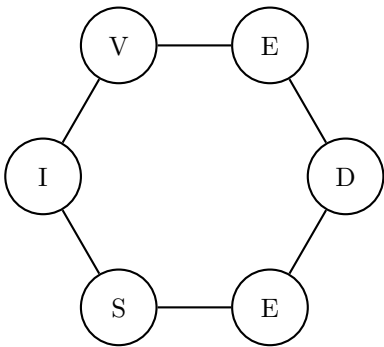

Rätsel Nummer 51

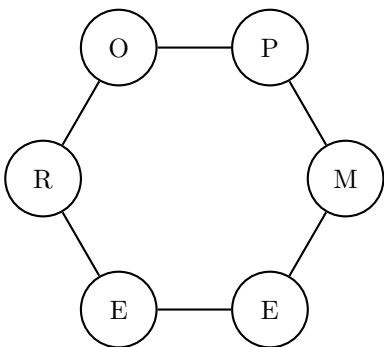

Rätsel Nummer 52

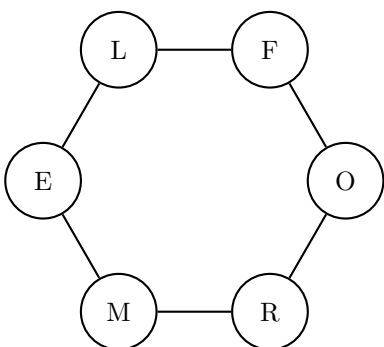

Rätsel Nummer 53

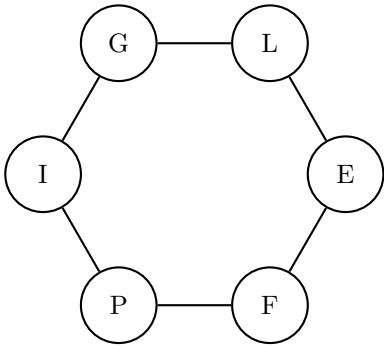

Rätsel Nummer 54

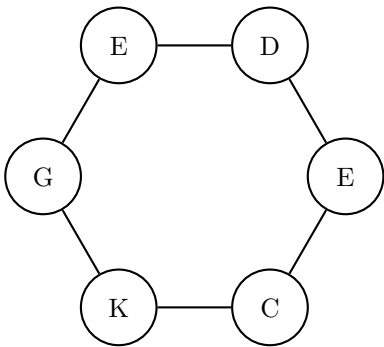

Rätsel Nummer 55

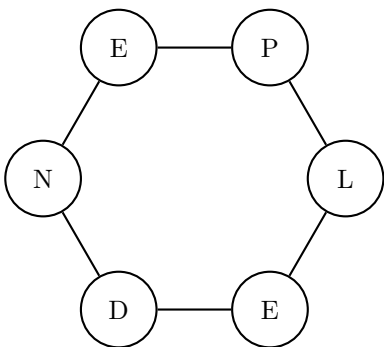

Rätsel Nummer 56

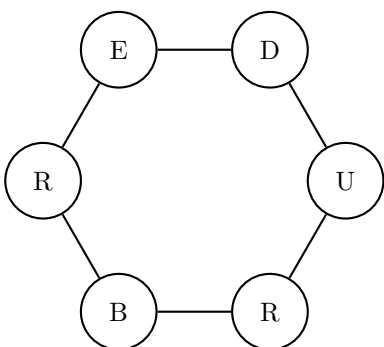

Rätsel Nummer 57

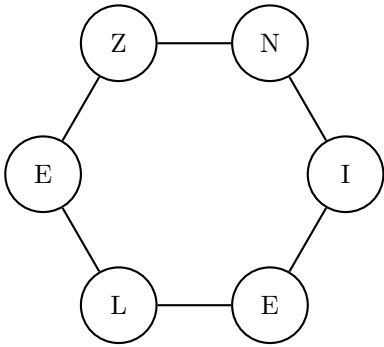

Rätsel Nummer 58

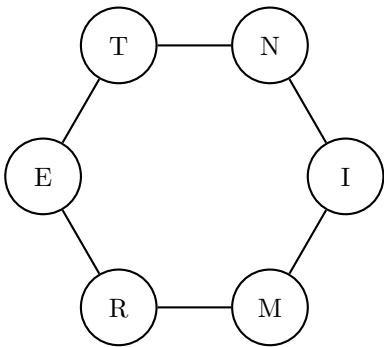

Rätsel Nummer 59

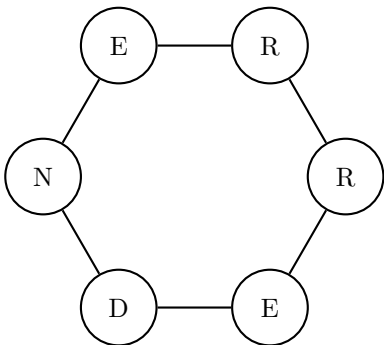

Rätsel Nummer 60

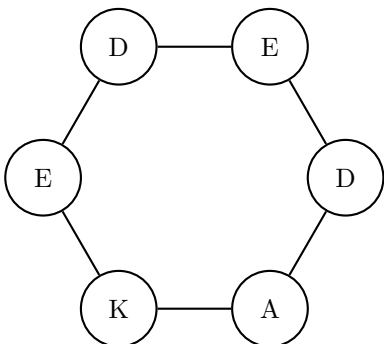

Rätsel Nummer 61

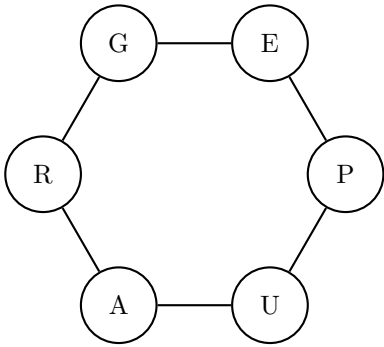

Rätsel Nummer 62

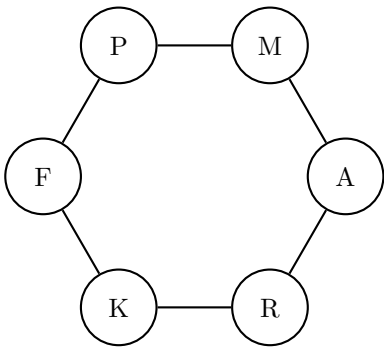

Rätsel Nummer 63

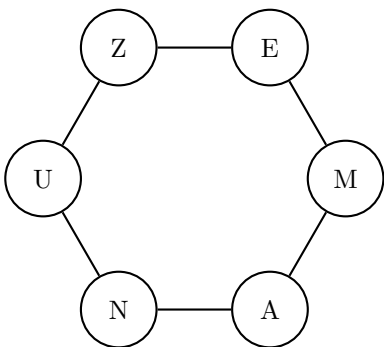

Rätsel Nummer 64

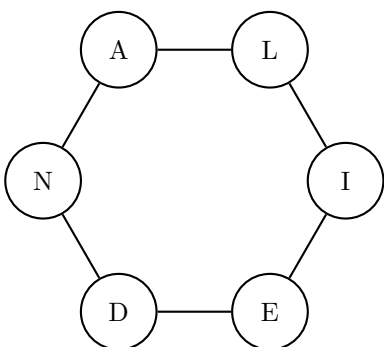

Rätsel Nummer 65

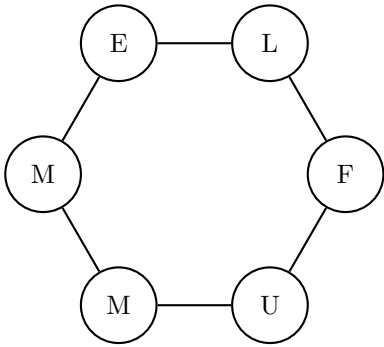

Rätsel Nummer 66

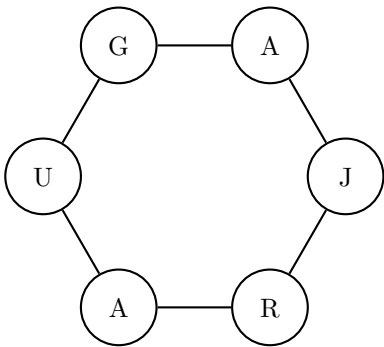

Rätsel Nummer 67

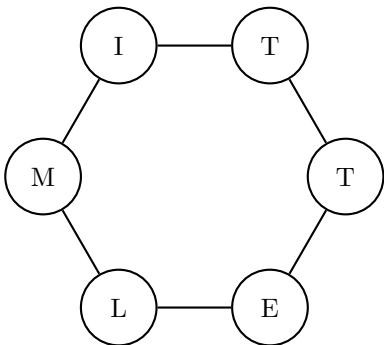

Rätsel Nummer 68

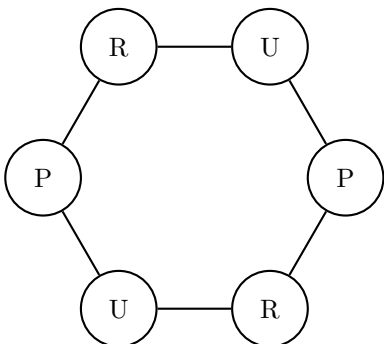

Rätsel Nummer 69

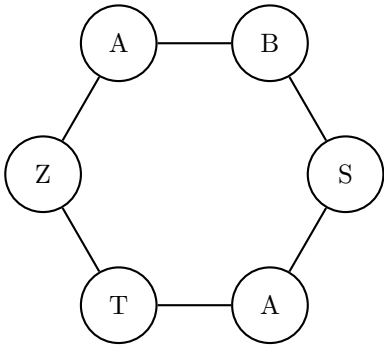

Rätsel Nummer 70

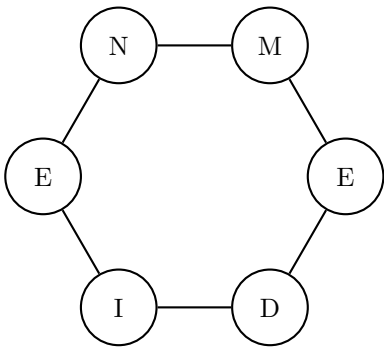

Rätsel Nummer 71

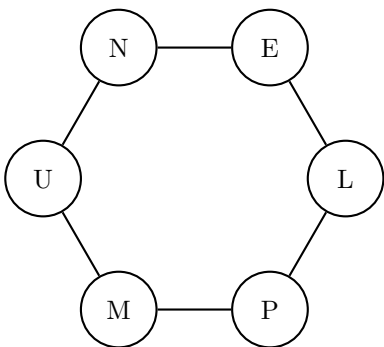

Rätsel Nummer 72

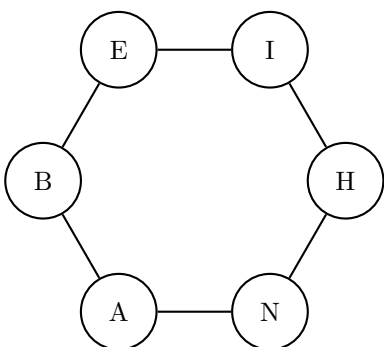

Rätsel Nummer 73

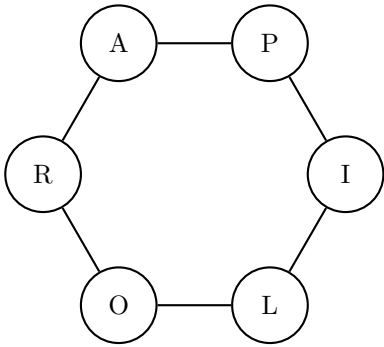

Rätsel Nummer 74

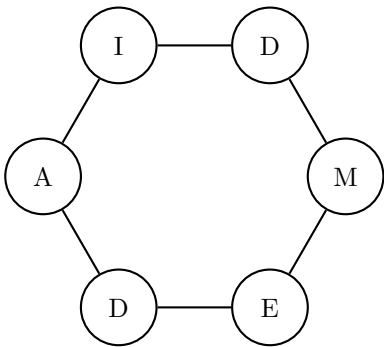

Rätsel Nummer 75

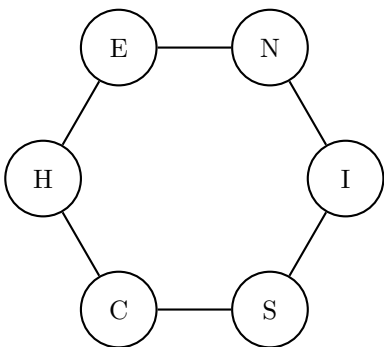

Rätsel Nummer 76

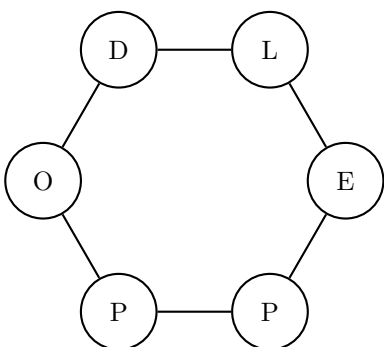

Rätsel Nummer 77

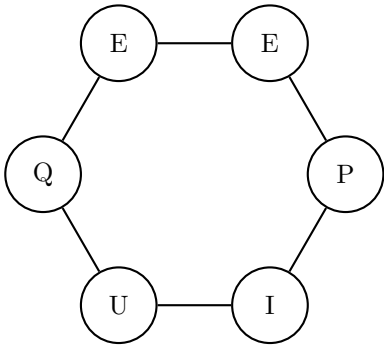

Rätsel Nummer 78

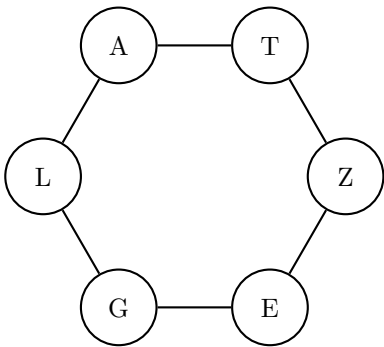

Rätsel Nummer 79

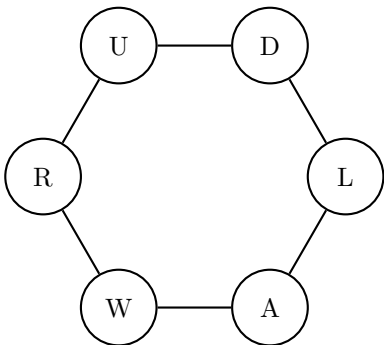

Rätsel Nummer 80

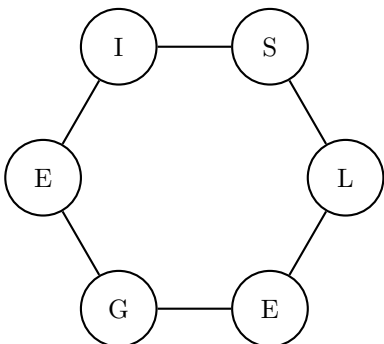

Rätsel Nummer 81

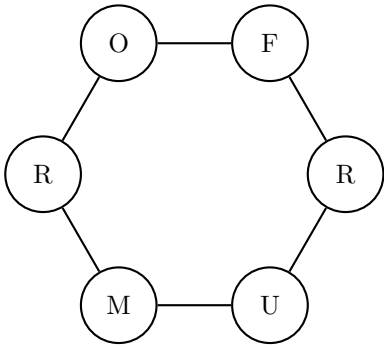

Rätsel Nummer 82

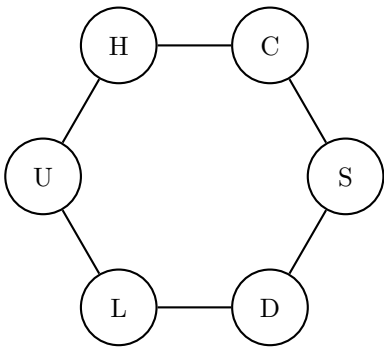

Rätsel Nummer 83

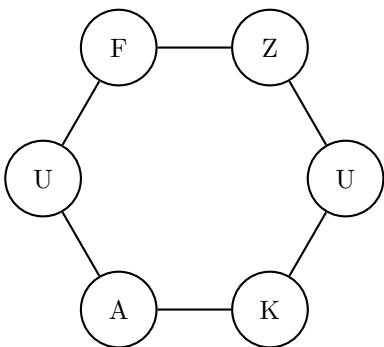

Rätsel Nummer 84

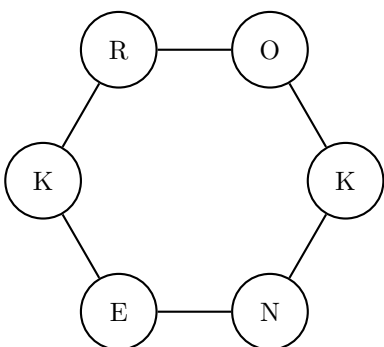

Rätsel Nummer 85

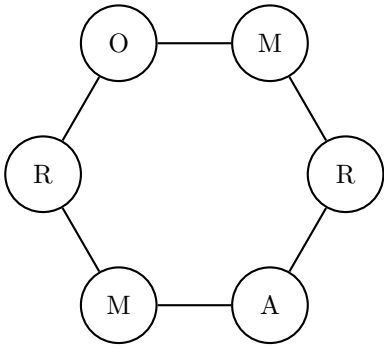

Rätsel Nummer 86

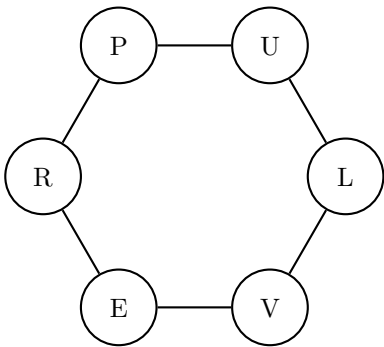

Rätsel Nummer 87

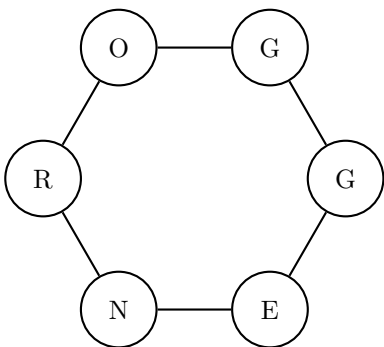

Rätsel Nummer 88

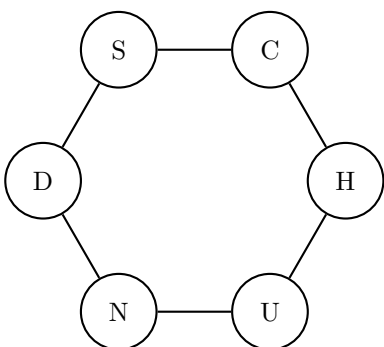

Rätsel Nummer 89

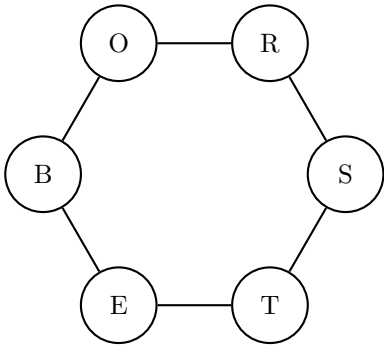

Rätsel Nummer 90

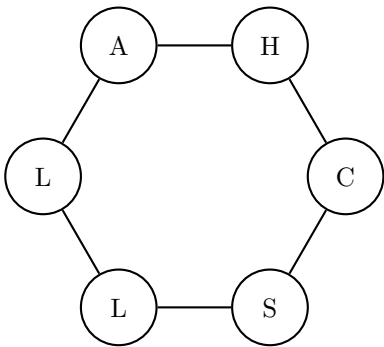

Rätsel Nummer 91

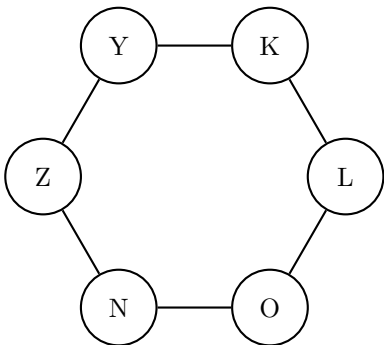

Rätsel Nummer 92

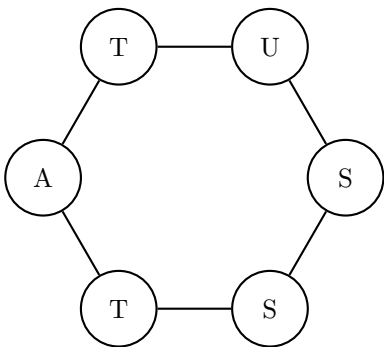

Rätsel Nummer 93

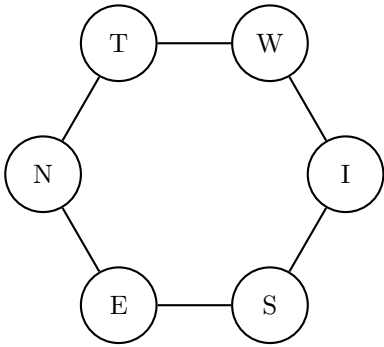

Rätsel Nummer 94

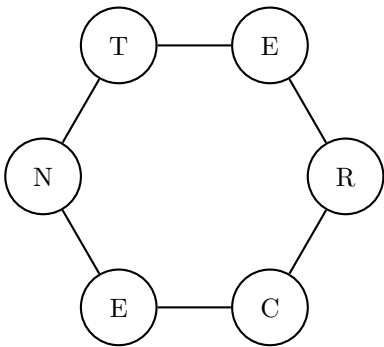

Rätsel Nummer 95

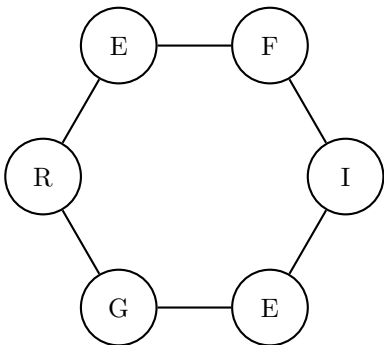

Rätsel Nummer 96

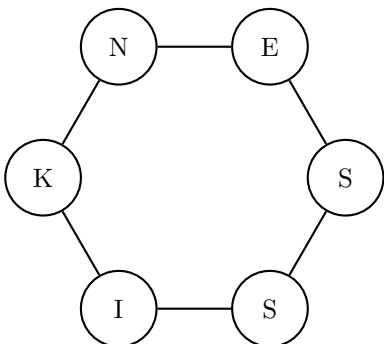

Rätsel Nummer 97

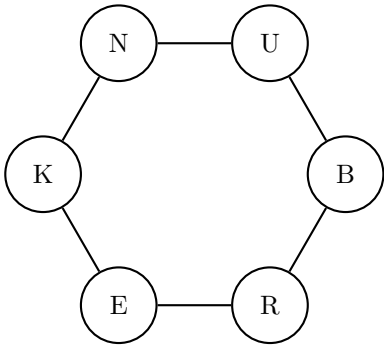

Rätsel Nummer 98

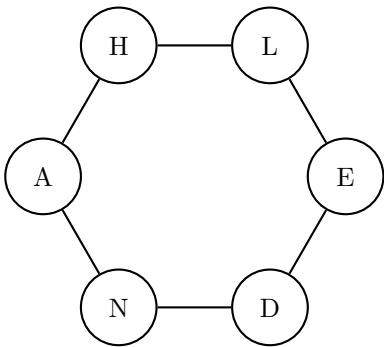

Rätsel Nummer 99

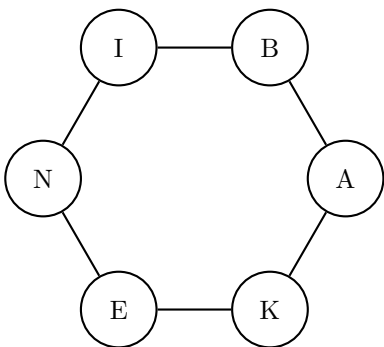

Rätsel Nummer 100

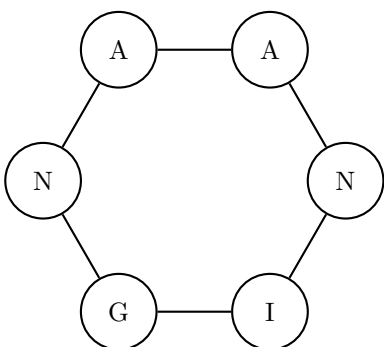

Lösung

1.MILIEU	34.HERBST	67.MITTEL
2.AHNUNG	35.KENNER	68.PURPUR
3.ANHALT	36.EREMIT	69.ABSATZ
4.ARREST	37.KUMMER	70.MEDIEN
5.GELENK	38.ORIENT	71.PLENUM
6.GEWALT	39.REPORT	72.ANHIEB
7.BOLZEN	40.WERBER	73.PAROLI
8.HUMBUG	41.KESSEL	74.DIADEM
9.BETRUG	42.FURCHE	75.NISCHE
10.GATTER	43.KLIPPE	76.DOPPEL
11.KOPPEL	44.SOLIST	77.EQUIPE
12.WAFFEL	45.ZEHNER	78.GLATZE
13.ZEMENT	46.NYMPHE	79.URWALD
14.ATHLET	47.DIRNDL	80.SIEGEL
15.DOMINO	48.ENTZUG	81.URFORM
16.DOUBLE	49.KITTEL	82.SCHULD
17.MORAST	50.DEVISE	83.ZUKAUF
18.DELIKT	51.EMPORE	84.KORKEN
19.GRANIT	52.FORMEL	85.MARMOR
20.PLANER	53.GIPFEL	86.PULVER
21.WEIHER	54.GEDECK	87.ROGGEN
22.KADETT	55.PENDEL	88.SCHUND
23.KELVIN	56.BRUDER	89.BORSTE
24.DIKTAT	57.EINZEL	90.SCHALL
25.DRAGEE	58.TERMIN	91.ZYKLON
26.SCHIFF	59.REDNER	92.STATUS
27.WEIZEN	60.DEKADE	93.WISENT
28.ZIERDE	61.GRAUPE	94.CENTER
29.CASINO	62.KRAMPF	95.GEIFER
30.HENKEL	63.ZUNAME	96.KISSEN
31.RACHEN	64.EILAND	97.BUNKER
32.AGONIE	65.FUMMEL	98.HANDEL
33.FUSION	66.JAGUAR	99.KABINE
		100.ANGINA