

100 Kreiswörter mit 6 Buchstaben Teil 6

Sascha Frank
www.kreiswort.de

12. Dezember 2012

Die gesuchten Wörter sind in einem Kreis aus Buchstaben versteckt. Das Wort kann vorwärts und rückwärts im Kreis stehen. Insgesamt gibt es 100 Rätsel zu lösen, am Ende gibt es eine kurze Lösung.

Mit freundlicher Unterstützung von:
Kinderzimmer Anastasia

Nageldesign Freiburg

Längenumrechner

Gesucht

ABBILD	GEWINN	PACKER
ACETON	GURGEL	PAPIER
ADVENT	HALLIG	PARDON
ANNEXE	HERING	PAROLE
ARMADA	IMPULS	PFORTE
ATMUNG	INSEKT	PLANKE
AUSWEG	JAMMER	PSYCHE
AZALEE	JUDOKA	RADIUM
BANANE	KACHEL	REITER
BENZOL	KANTON	SAFARI
BESITZ	KAPUZE	SALBEI
BUCHSE	KIESEL	SATTEL
BYPASS	KIRMES	SCHACH
DAMAST	KITSCH	SCHELM
DIENST	KNILCH	SCHOCK
DISKUS	KNIRPS	SEGLER
DOZENT	KOLBEN	SENDER
DREHER	KONSUL	SIRENE
EPILOG	KONTEN	SPECHT
ERBGUT	KORDEL	STATIK
ERDGAS	KOSTEN	STAUDE
ERWERB	KRABBE	STORNO
FIEBER	KRUSTE	TEMPEL
FLAKON	LATEIN	THEMEN
FRATZE	LEXIKA	TOMATE
FREUND	MAHNER	TRUMPF
FRUCHT	MANDEL	UNIKUM
FUNDUS	MARDER	UTOPIE
FUTTER	MAXIME	VERRUF
GAUNER	METIER	VORORT
GEGNER	MUSTER	WIMPEL
GEHUPE	NOTRUF	WINZER
GEWEBE	NOUGAT	ZIRKUS
		ZYKLUS

Rätsel Nummer 1

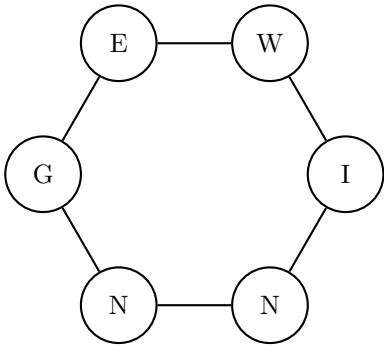

Rätsel Nummer 2

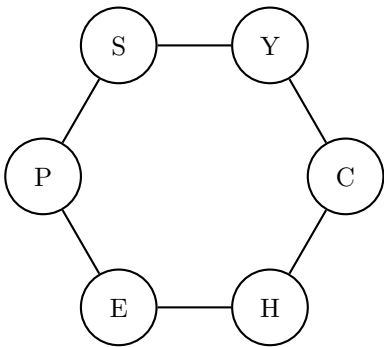

Rätsel Nummer 3

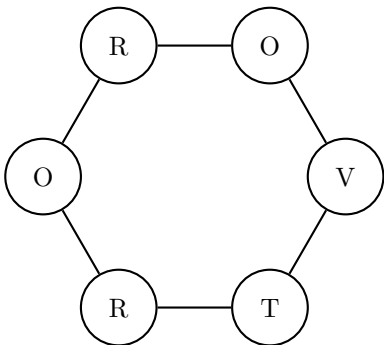

Rätsel Nummer 4

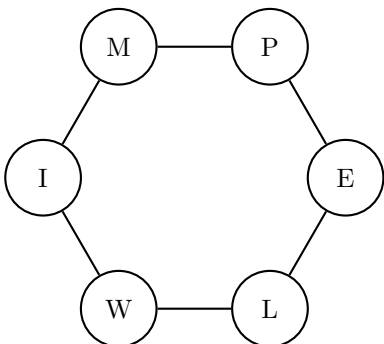

Rätsel Nummer 5

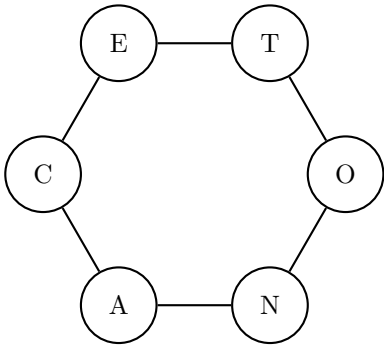

Rätsel Nummer 6

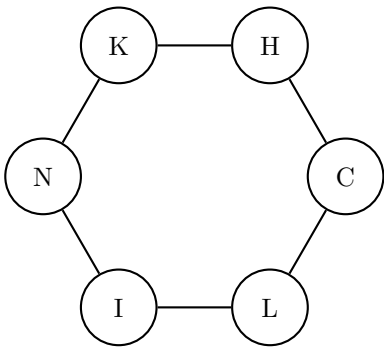

Rätsel Nummer 7

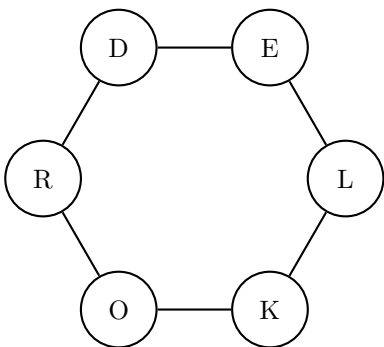

Rätsel Nummer 8

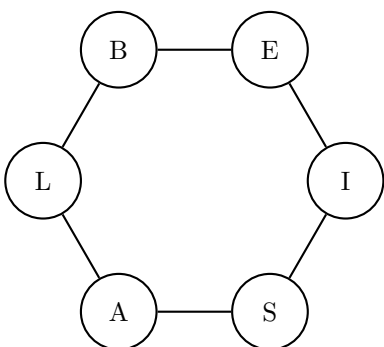

Rätsel Nummer 9

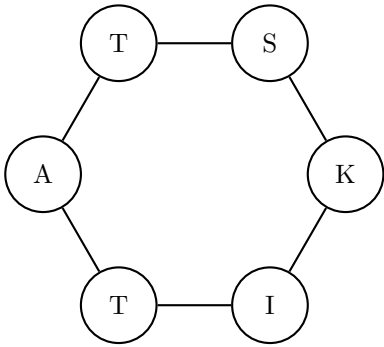

Rätsel Nummer 10

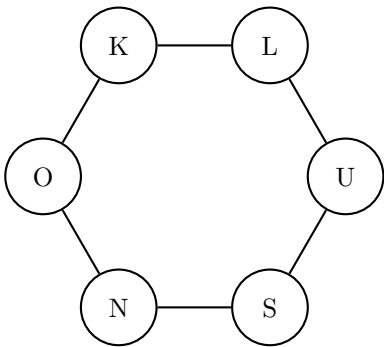

Rätsel Nummer 11

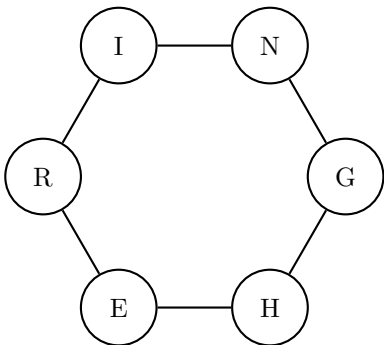

Rätsel Nummer 12

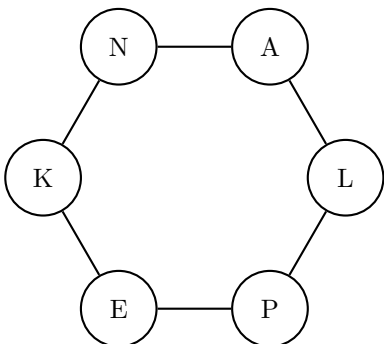

Rätsel Nummer 13

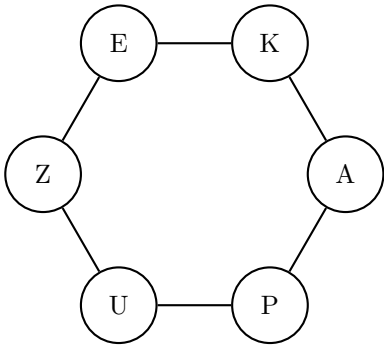

Rätsel Nummer 14

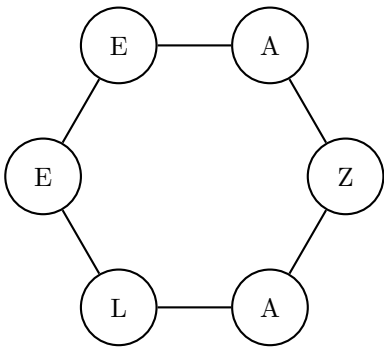

Rätsel Nummer 15

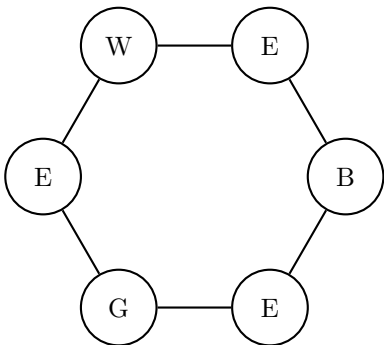

Rätsel Nummer 16

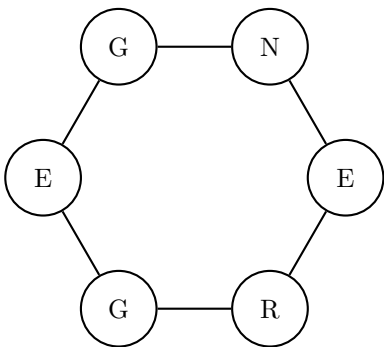

Rätsel Nummer 17

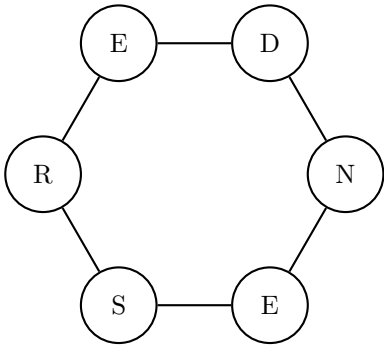

Rätsel Nummer 18

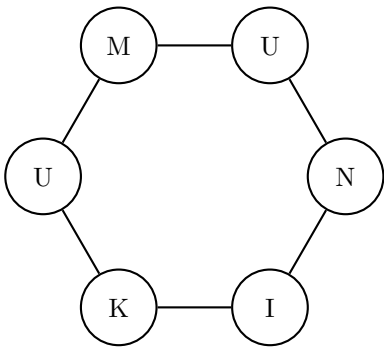

Rätsel Nummer 19

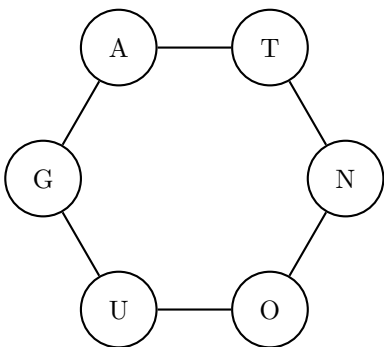

Rätsel Nummer 20

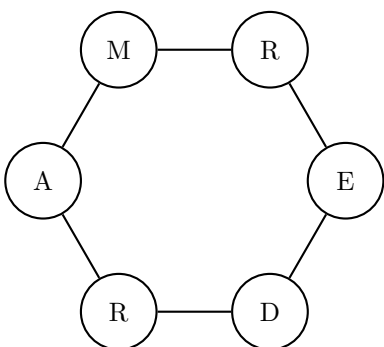

Rätsel Nummer 21

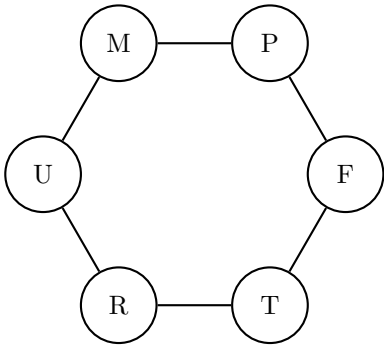

Rätsel Nummer 22

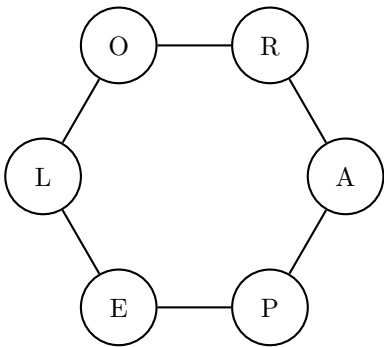

Rätsel Nummer 23

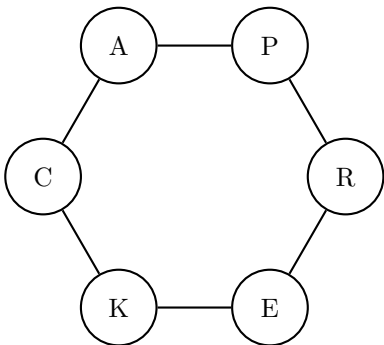

Rätsel Nummer 24

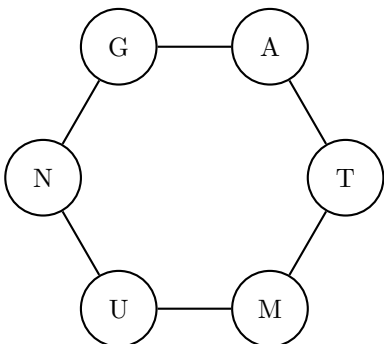

Rätsel Nummer 25

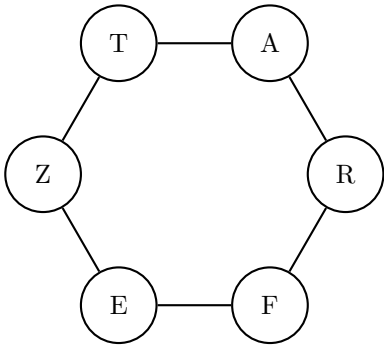

Rätsel Nummer 26

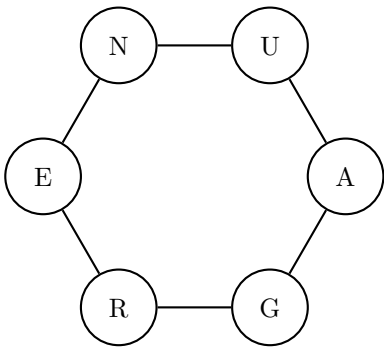

Rätsel Nummer 27

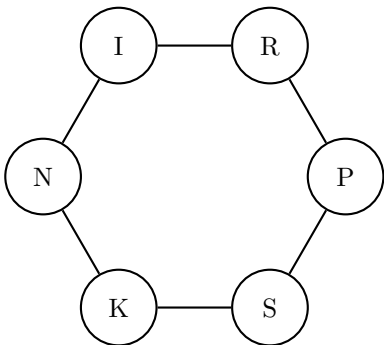

Rätsel Nummer 28

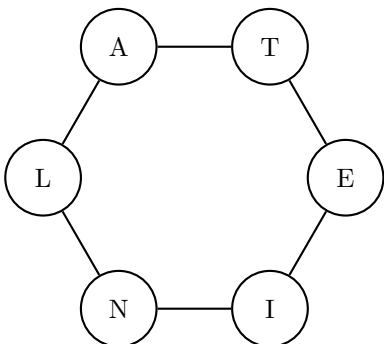

Rätsel Nummer 29

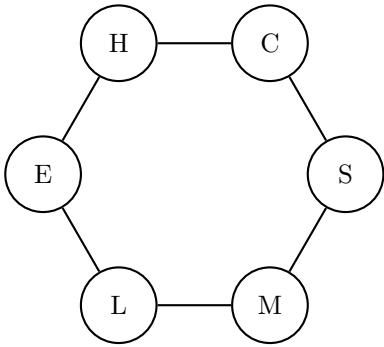

Rätsel Nummer 30

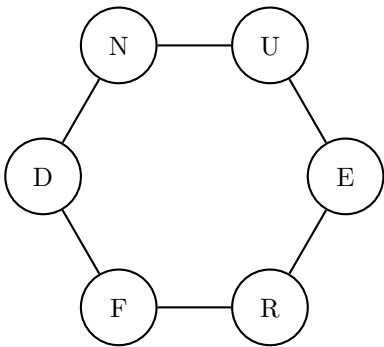

Rätsel Nummer 31

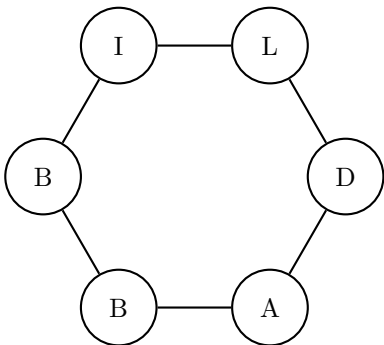

Rätsel Nummer 32

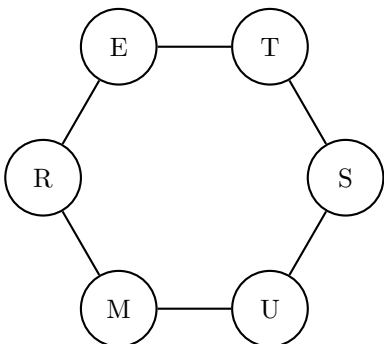

Rätsel Nummer 33

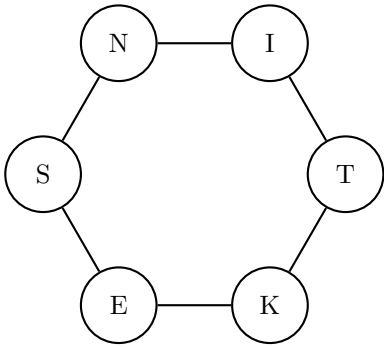

Rätsel Nummer 34

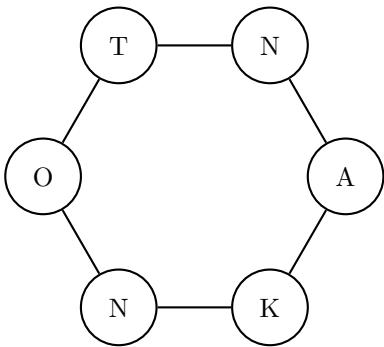

Rätsel Nummer 35

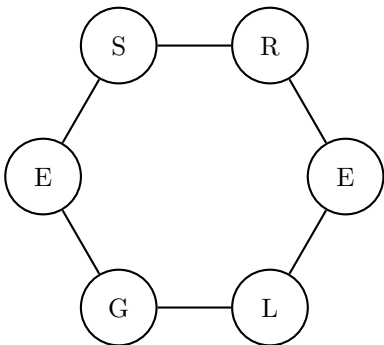

Rätsel Nummer 36

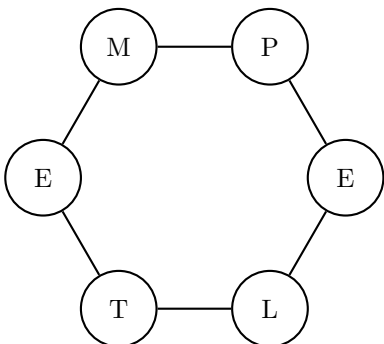

Rätsel Nummer 37

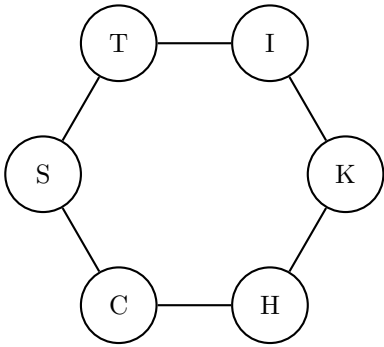

Rätsel Nummer 38

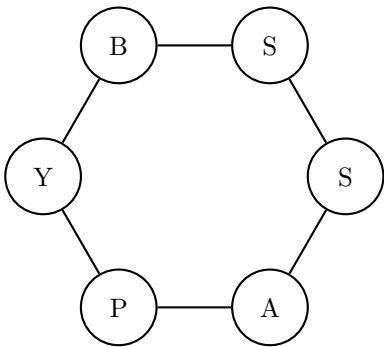

Rätsel Nummer 39

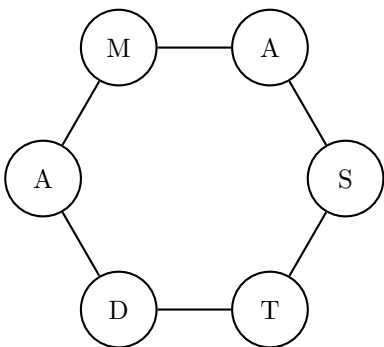

Rätsel Nummer 40

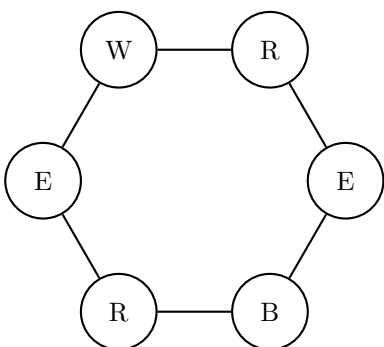

Rätsel Nummer 41

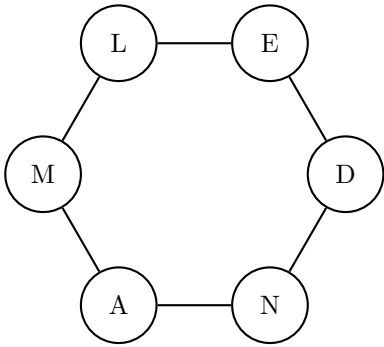

Rätsel Nummer 42

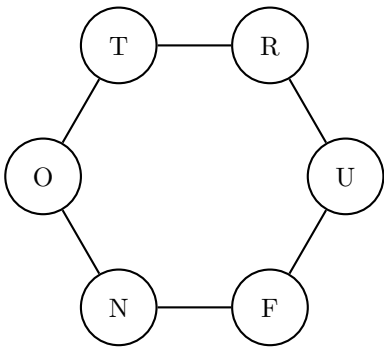

Rätsel Nummer 43

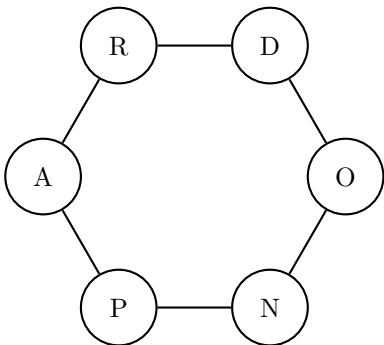

Rätsel Nummer 44

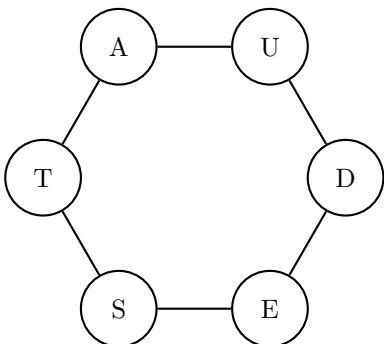

Rätsel Nummer 45

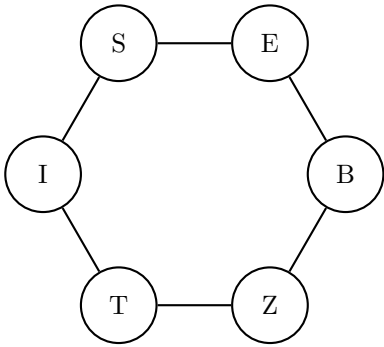

Rätsel Nummer 46

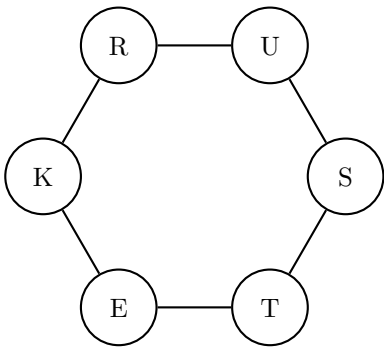

Rätsel Nummer 47

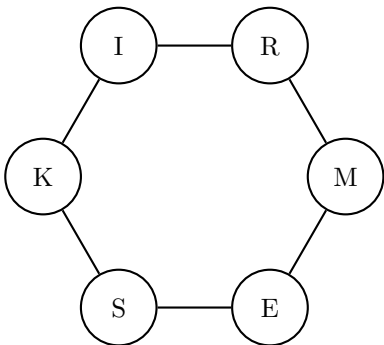

Rätsel Nummer 48

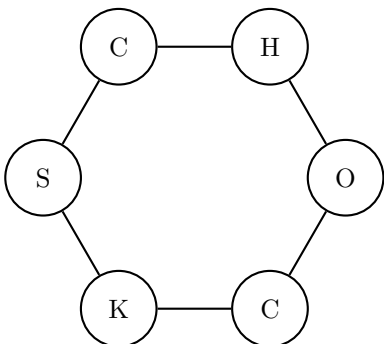

Rätsel Nummer 49

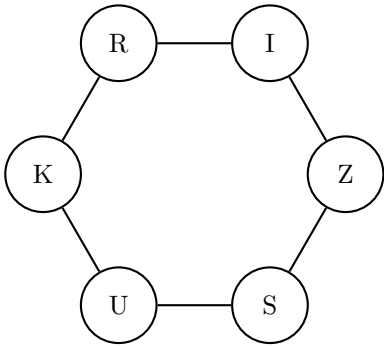

Rätsel Nummer 50

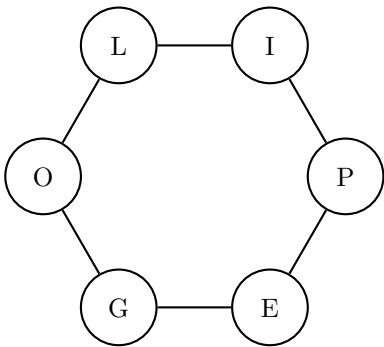

Rätsel Nummer 51

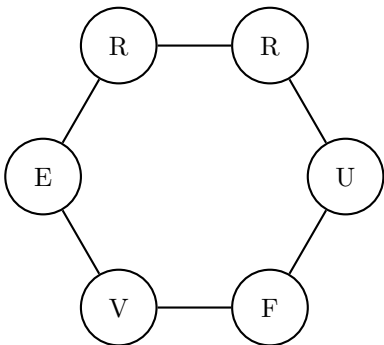

Rätsel Nummer 52

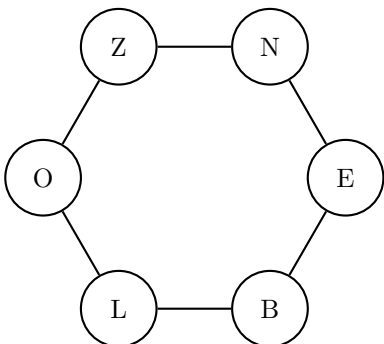

Rätsel Nummer 53

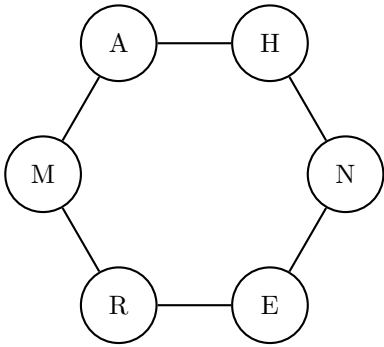

Rätsel Nummer 54

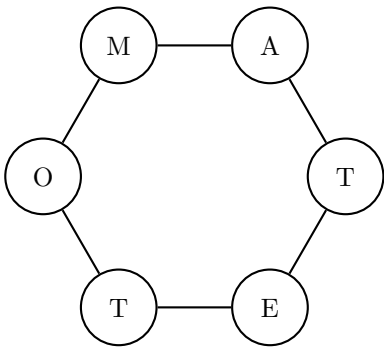

Rätsel Nummer 55

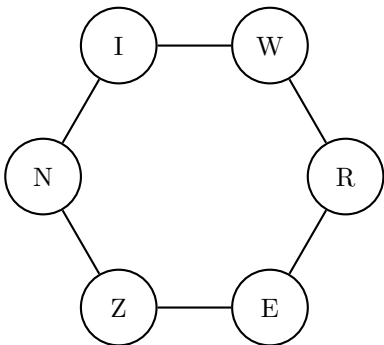

Rätsel Nummer 56

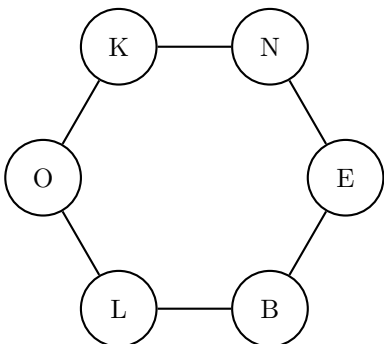

Rätsel Nummer 57

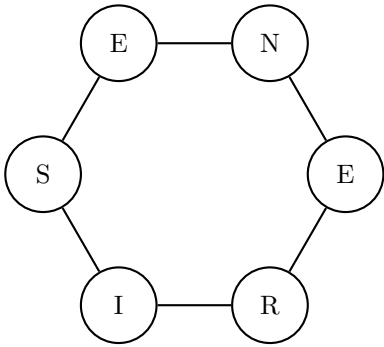

Rätsel Nummer 58

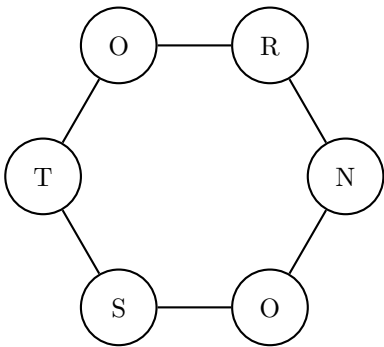

Rätsel Nummer 59

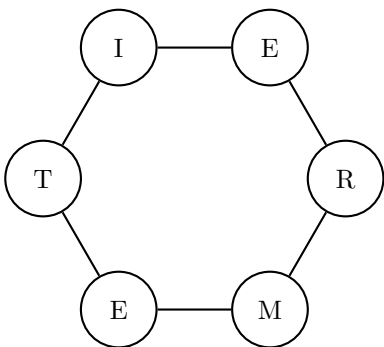

Rätsel Nummer 60

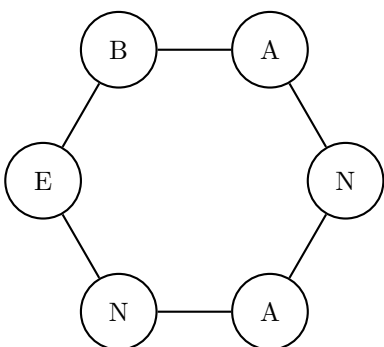

Rätsel Nummer 61

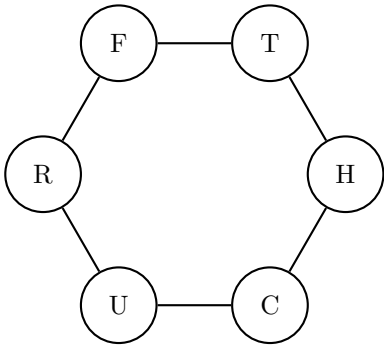

Rätsel Nummer 62

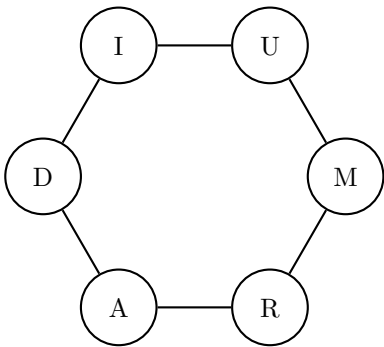

Rätsel Nummer 63

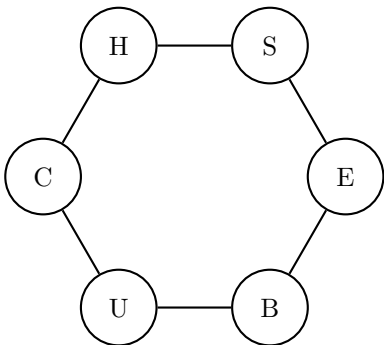

Rätsel Nummer 64

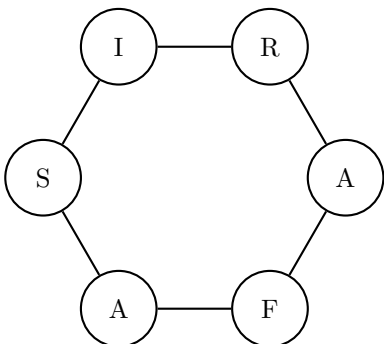

Rätsel Nummer 65

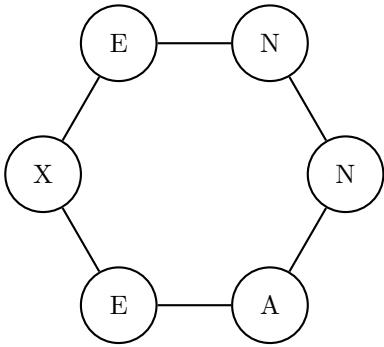

Rätsel Nummer 66

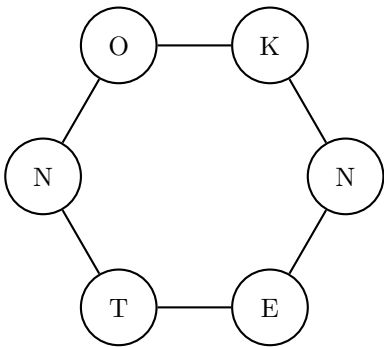

Rätsel Nummer 67

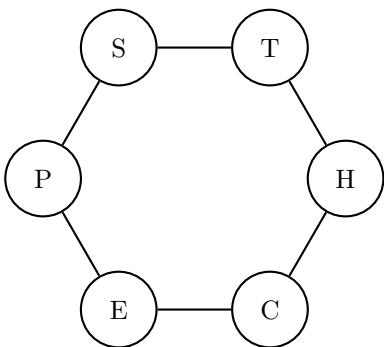

Rätsel Nummer 68

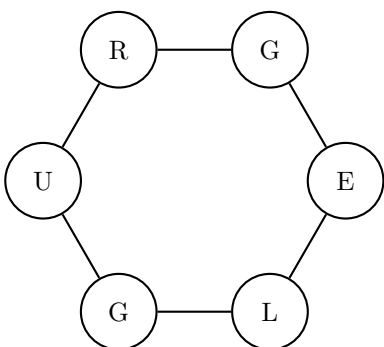

Rätsel Nummer 69

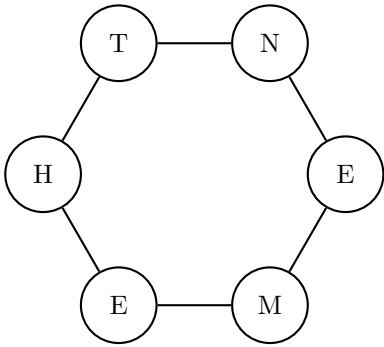

Rätsel Nummer 70

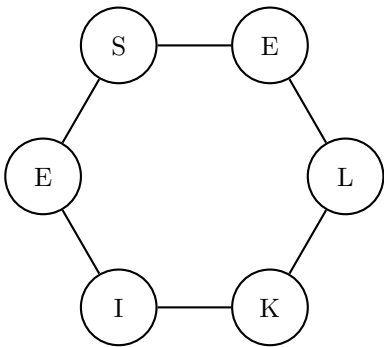

Rätsel Nummer 71

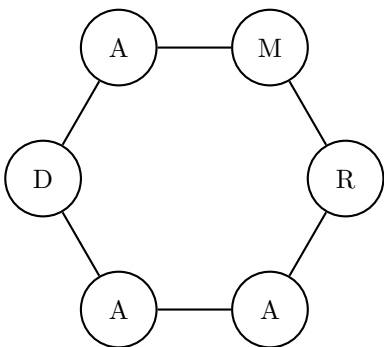

Rätsel Nummer 72

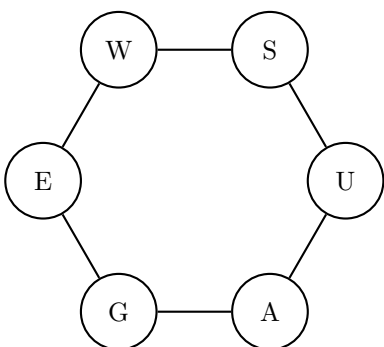

Rätsel Nummer 73

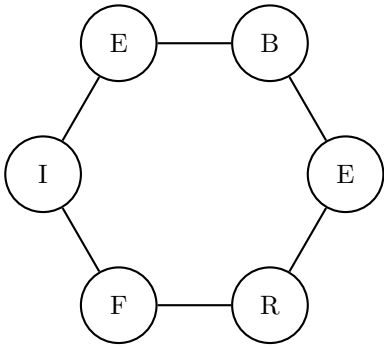

Rätsel Nummer 74

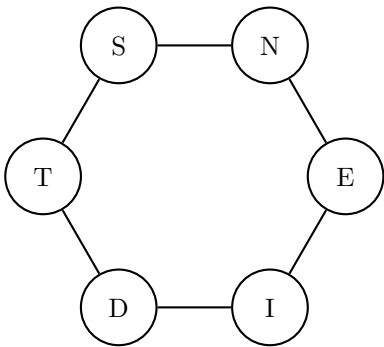

Rätsel Nummer 75

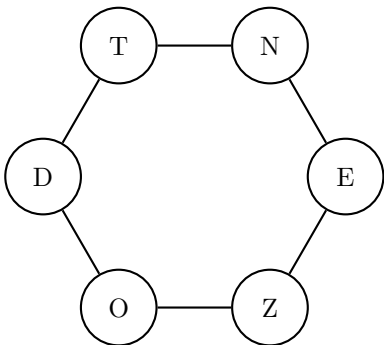

Rätsel Nummer 76

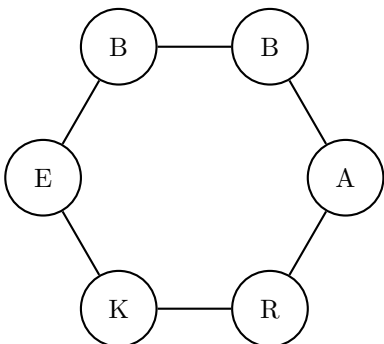

Rätsel Nummer 77

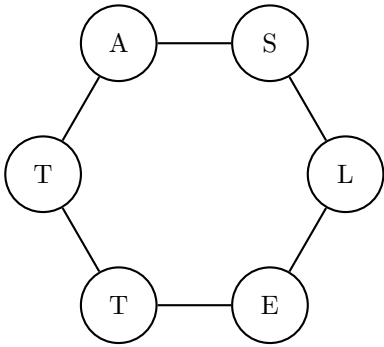

Rätsel Nummer 78

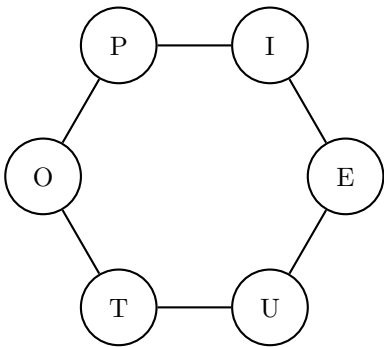

Rätsel Nummer 79

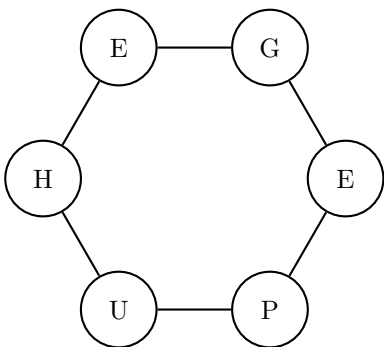

Rätsel Nummer 80

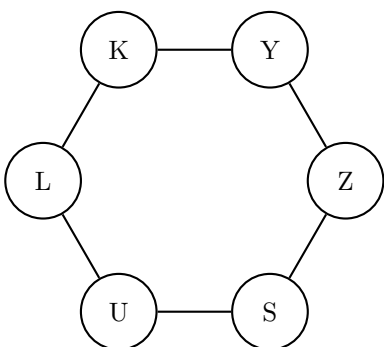

Rätsel Nummer 81

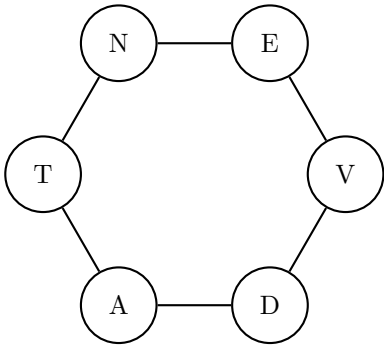

Rätsel Nummer 82

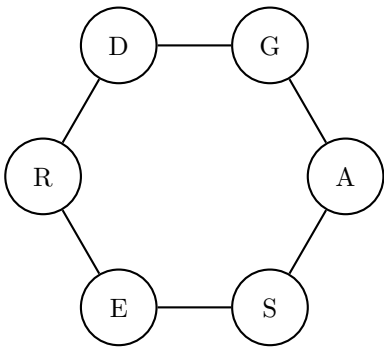

Rätsel Nummer 83

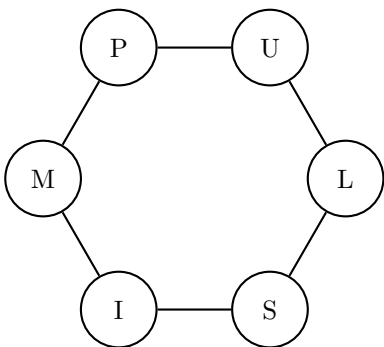

Rätsel Nummer 84

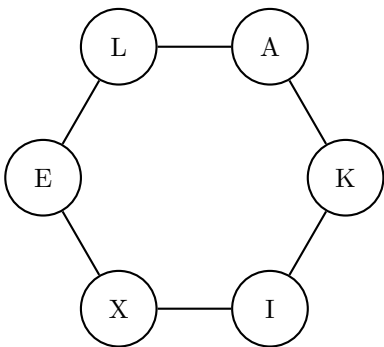

Rätsel Nummer 85

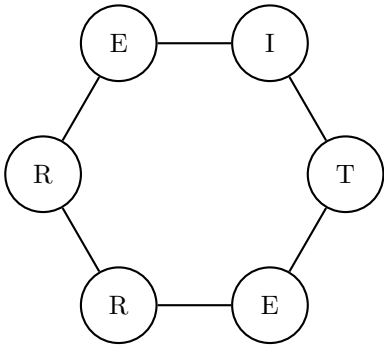

Rätsel Nummer 86

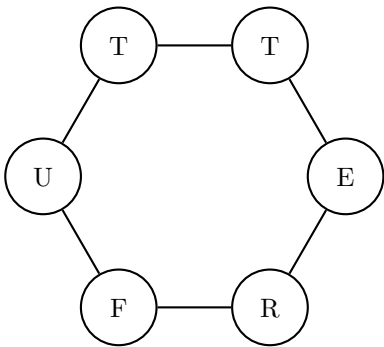

Rätsel Nummer 87

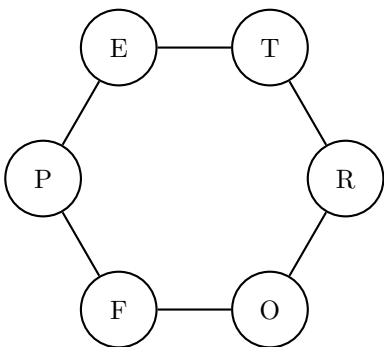

Rätsel Nummer 88

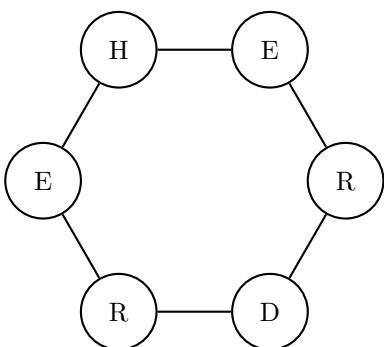

Rätsel Nummer 89

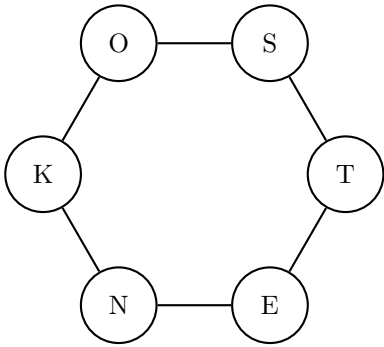

Rätsel Nummer 90

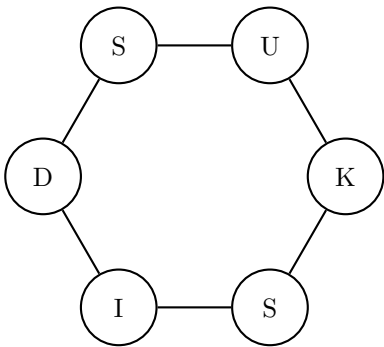

Rätsel Nummer 91

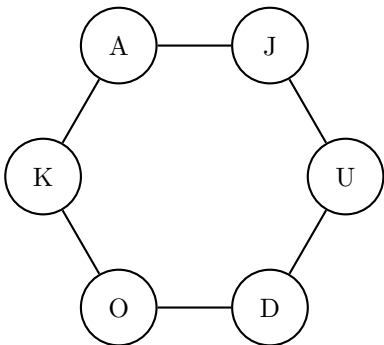

Rätsel Nummer 92

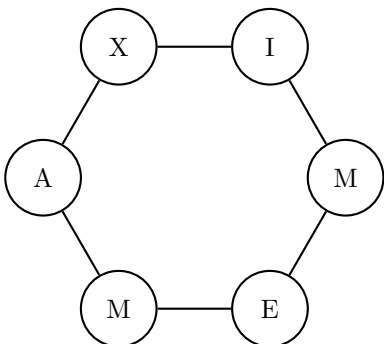

Rätsel Nummer 93

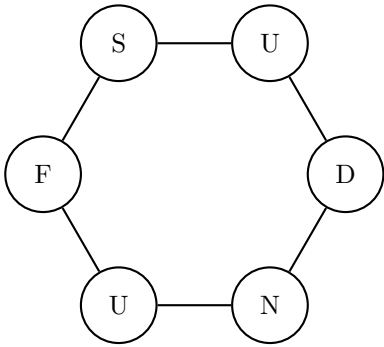

Rätsel Nummer 94

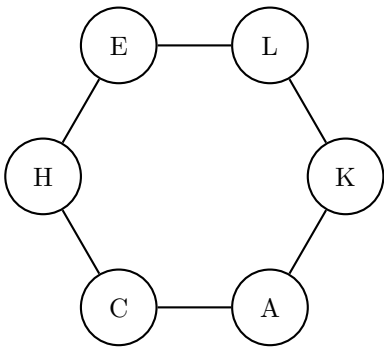

Rätsel Nummer 95

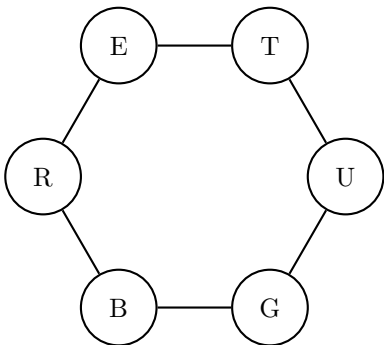

Rätsel Nummer 96

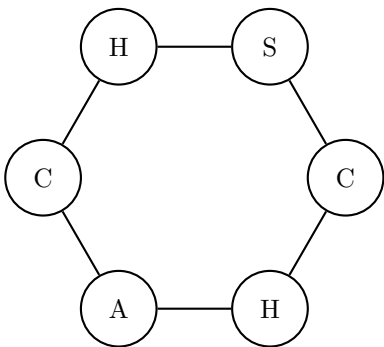

Rätsel Nummer 97

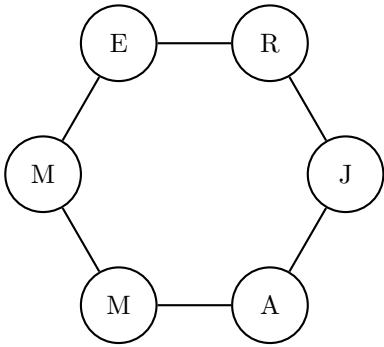

Rätsel Nummer 98

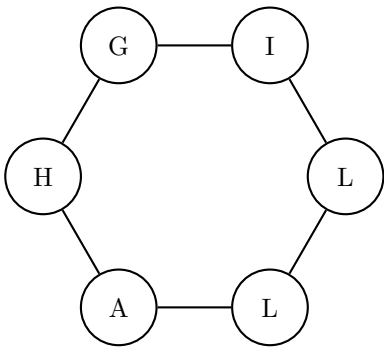

Rätsel Nummer 99

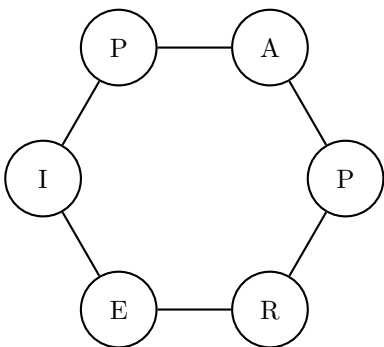

Rätsel Nummer 100

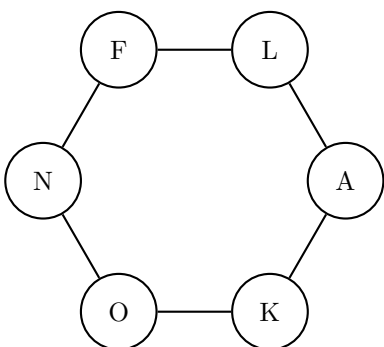

Lösung

1.GEWINN	34.KANTON	67.SPECHT
2.PSYCHE	35.S EGLER	68.GURGEL
3.VORORT	36.TEMPEL	69.THEMEN
4.WIMPEL	37.KITSCH	70.KIESEL
5.ACETON	38.BYPASS	71.ARMADA
6.KNILCH	39.DAMAST	72.AUSWEG
7.KORDEL	40.ERWERB	73.FIEBER
8.SALBEI	41.MANDEL	74.DIENST
9.STATIK	42.NOTRUF	75.DOZENT
10.KONSUL	43.PARDON	76.KRABBE
11.HERING	44.STAUDE	77.SATTEL
12.PLANKE	45.BESITZ	78.UTOPIE
13.KAPUZE	46.KRUSTE	79.GEHUPE
14.AZALEE	47.KIRMES	80.ZYKLUS
15.GEWEBE	48.SCHOCK	81.ADVENT
16.GEGNER	49.ZIRKUS	82.ERDGAS
17.SENDER	50.EPILOG	83.IMPULS
18.UNIKUM	51.VERRUF	84.LEXIKA
19.NOUGAT	52.BENZOL	85.REITER
20.MARDER	53.MAHNER	86.FUTTER
21.TRUMPF	54.TOMATE	87.PFORTE
22.PAROLE	55.WINZER	88.DREHER
23.PACKER	56.KOLBEN	89.KOSTEN
24.ATMUNG	57.SIRENE	90.DISKUS
25.FRATZE	58.STORNO	91.JUDOKA
26.GAUNER	59.METIER	92.MAXIME
27.KNIRPS	60.BANANE	93.FUNDUS
28.LATEIN	61.FRUCHT	94.KACHEL
29.SCHELM	62.RADIUM	95.ERBGUT
30.FREUND	63.BUCHSE	96.SCHACH
31.ABBILD	64.SAFARI	97.JAMMER
32.MUSTER	65.ANNEXE	98.HALLIG
33.INSEKT	66.KONTEN	99.PAPIER
		100.FLAKON